

# THE CAMERA CRAFTSMAN

MAY - JUNE 1974

75¢



IN THIS ISSUE

## OLYMPUS OM-1

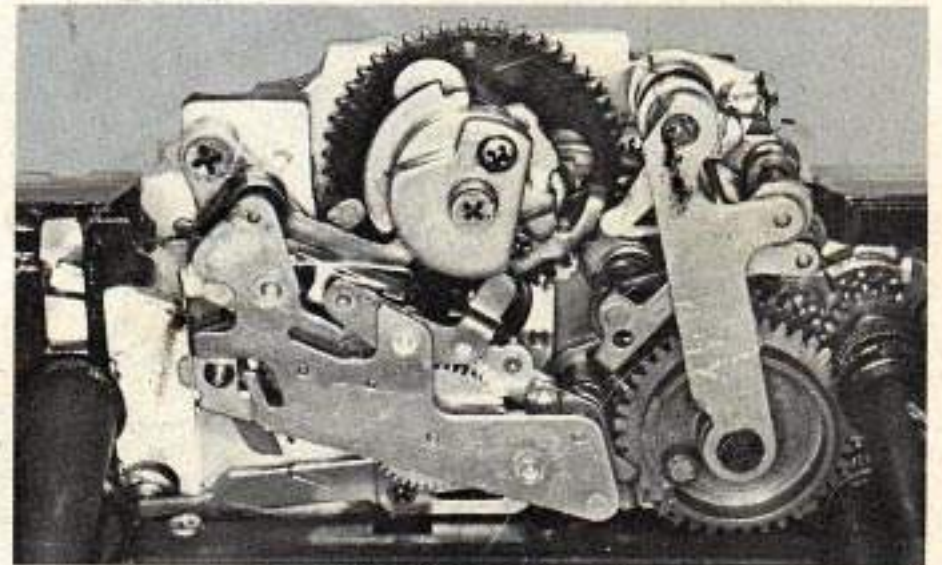
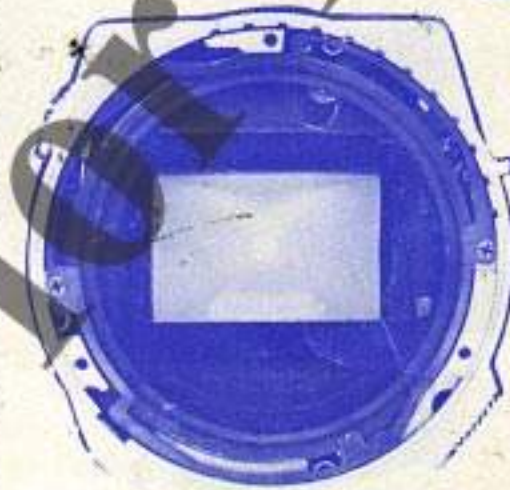

REPORT ON CHICAGO SHOW

<http://olympus.dementia.org/Hardware>

Special thanks to Ponder & Best, who generously provided the Olympus OM-1 for our report.

## THE OLYMPUS OM-1

The "Olympus" name has long been synonymous with camera compactness — those tiny, palm-size cameras that slip readily into pocket or purse. But through the years, the Olympus nameplate also seemed to symbolize half-frame 35mm formats.

So perhaps tradition had already decided one of the qualifications of the new Olympus OM-1. It had to be small. The departure from tradition turned out to be the film format. The Olympus OM-1 made its photographic debut heralded as "the world's smallest full-frame 35mm SLR."

Designing such a tiny full-frame SLR was quite an engineering trick in itself. But Olympus went even further than designing the camera — they designed a camera system. The OM-1 became the nerve center for an extensive system abounding in accessories. In all, there are around 280 accessories, including at least 30 lenses, a dozen interchangeable focusing screens, and a featherweight motor-drive unit.

Our first questions regarding the new OM-1, quite naturally, involved the size. Is the OM-1 simply a scaled-down SLR with small, delicate parts? Or is it truly unique? Is the compactness a result of new breakthroughs in design, or is it the result of a compromise of features?

First appearances indicate that the OM-1 clings to time-proven principles. The rubberized-cloth curtains travel horizontally across the aperture. Metering is semi-automatic, a center-the-needle system. For cross-coupling, Olympus stuck by the mechanical method with a rather intricate series of coupling cords.

So far, the OM-1 sounds pretty familiar. But it's only the basic design that makes any concession to convention. A closer look shows that Olympus did quite a job of restyling the basics. Cleverly using every nook of available space, Olympus packed the favorite SLR features into a compact and comfortable camera.

One of the first hints of uniqueness is the positioning of the camera controls. That knob on top of the camera looks like a shutter-speed knob, but it's not. Rather, it's the film-speed knob, Fig. 2. Realizing that most people are accustomed to having the shutter-speed knob at the top of the camera, Olympus provided a special lock to retain the film-speed setting. You must depress the film-speed-lock

# OLYMPUS OM-1

by Lawrence C. Lyells

Part 1 of a two-part article. The conclusion will appear in the July/August Camera Craftsman.



Figure 1



Figure 2

button, Fig. 2, before you can turn the film-speed knob. The locking provision prevents any chance of accidentally changing the film-speed setting.

So where's the shutter-speed control? It's a ring encircling the lens mount, Fig. 1. If your present camera is a Nikkormat, you'll find the shutter-speed-setting ring to be comfortably located. But otherwise, the control position may at first be somewhat disconcerting.

The shutter-speed-setting ring couples to the speed-control cam stack. That's the cam stack that controls the slit width, the pallet engagement, and the retard engagement. Here's one place the OM-1 displays some true originality — the entire speed-control mechanism is at the bottom of the camera. Not just the speeds escapement, mind you — the entire control mechanism.

And therein lies one of the keys to the camera's compactness. With everything bunched together at the bottom of the camera, Fig. 3, there's no wasted space — and no coupling linkages running to the top of the camera. Tiny, delicate curtain-control parts? Not at all. They're as hefty as you'd expect to see in larger, bulkier SLR's.

Fig. 3 doesn't show the exposure-meter cross-coupling system — that remains with the front plate. A cord behind the lens-mounting ring connects the shutter-speed-setting ring to the galvanometer housing. From a service standpoint, repair technicians aren't all that fond of coupling cords. But the cords are great space-savers. In the OM-1, the cords run in a circle; they're routed around the lens opening, again making maximum use of available space.

The cord-coupling system also joins the diaphragm-setting ring to the galvanometer for full-aperture metering. To remove the lens from its bayonet mount, depress the lens latch near the depth-of-field calibrations, Fig. 4. (The other button on the lens, almost identical in appearance to the lens latch, is the depth-of-field preview, Fig. 1.) Now, rotate the lens counterclockwise until you can remove it from the camera. Replace the lens by first aligning the red dot at the center of the depth-of-field scale with the red dot on the lens-mounting ring.

With the lens removed, you can see the tab that couples the diaphragm to

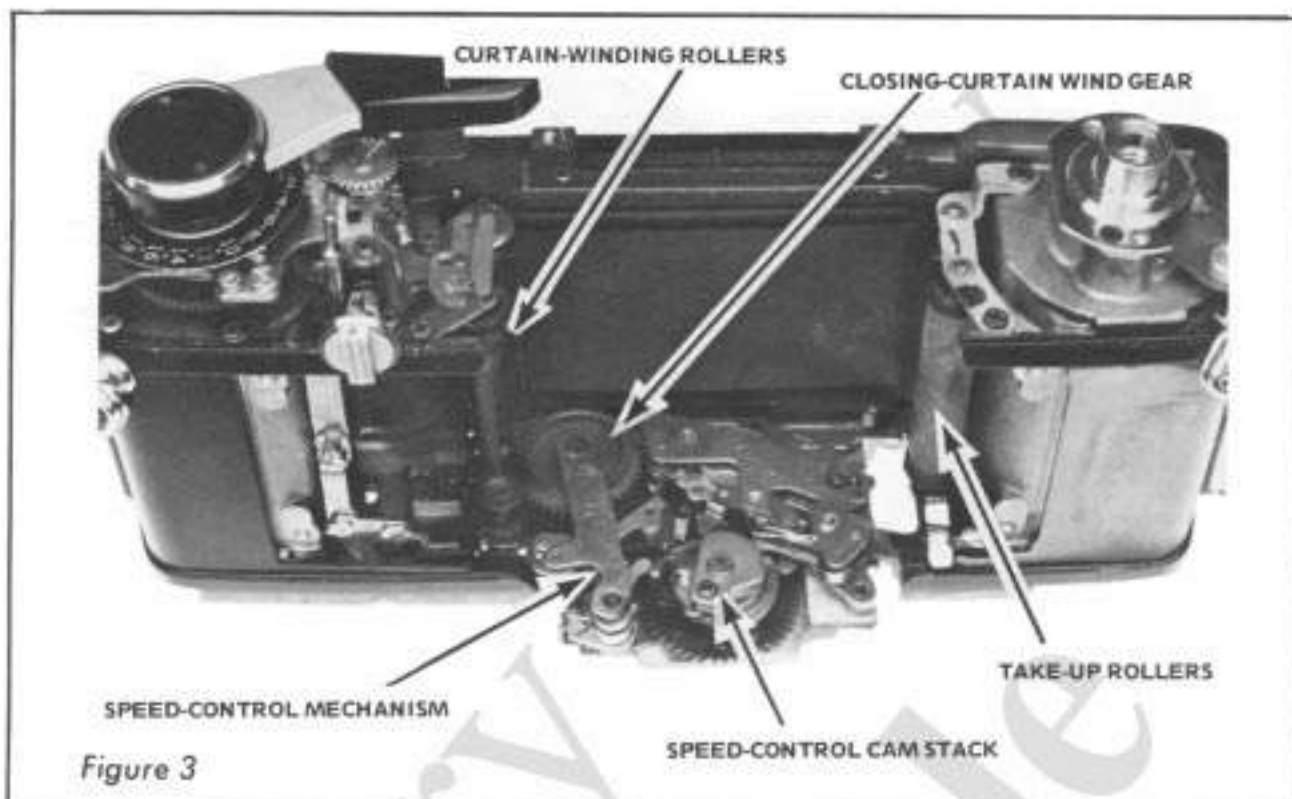

Figure 3



Figure 4

the exposure-meter system, Fig. 5. Changing the diaphragm setting rotates the tab. In turn, the tab



Figure 5

positions the aperture-sensing ring, a ring encircling the lens opening inside the camera, Fig. 6. As you set a larger f/stop, the tab turns the aperture-sensing ring clockwise — against its spring tension — to rotate the galvanometer housing.

While inside the mirror cage, notice the extra-large reflex mirror. The large mirror eliminates image cutoff when using long focal-length lenses, up through the OM-1's 800mm telephoto. But you can't as yet see the truly unique feature concerning the mirror — that's the air-damping piston, a shock absorber that reduces noise and vibration. The OM-1's mirror mechanism marks the first time an air-damping piston has been used in a 35mm SLR.

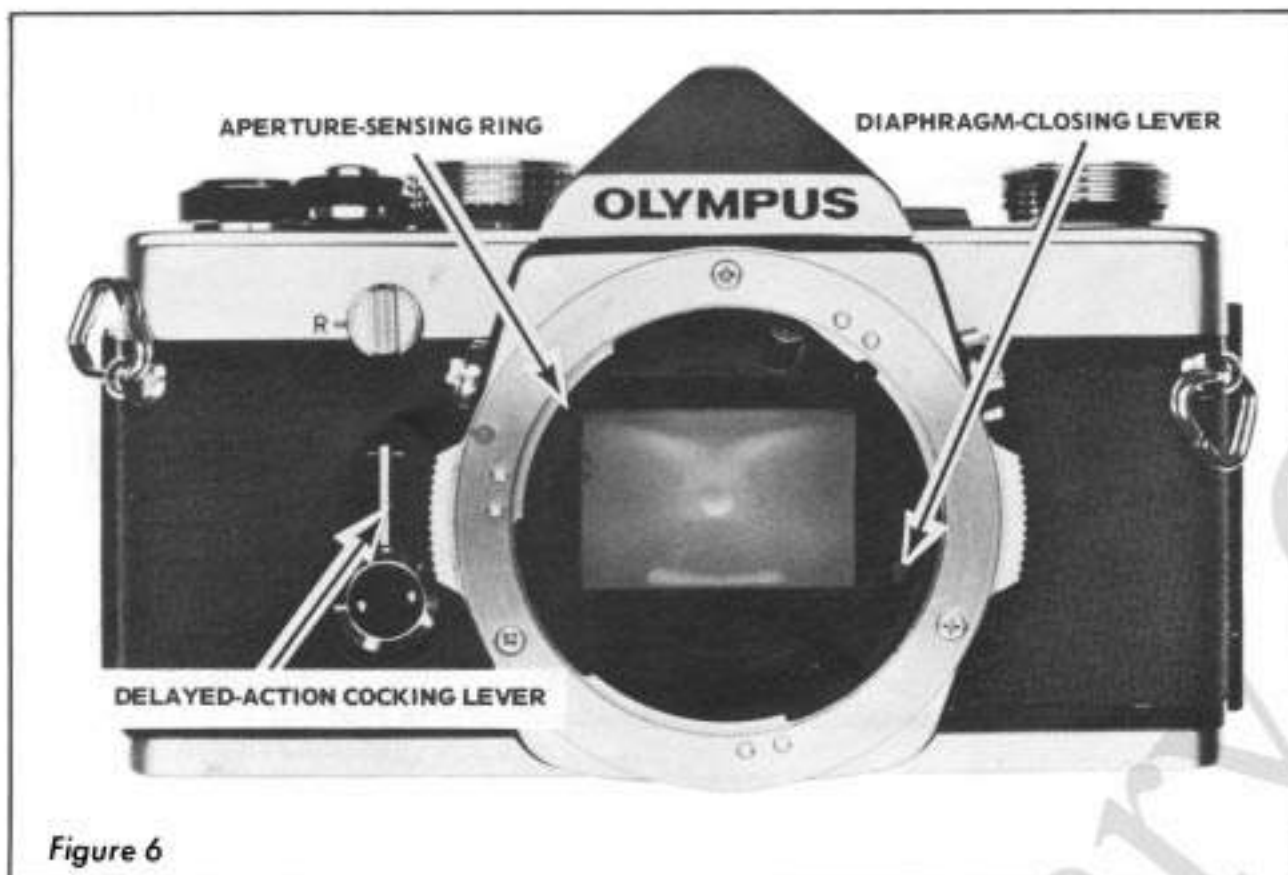

Figure 6

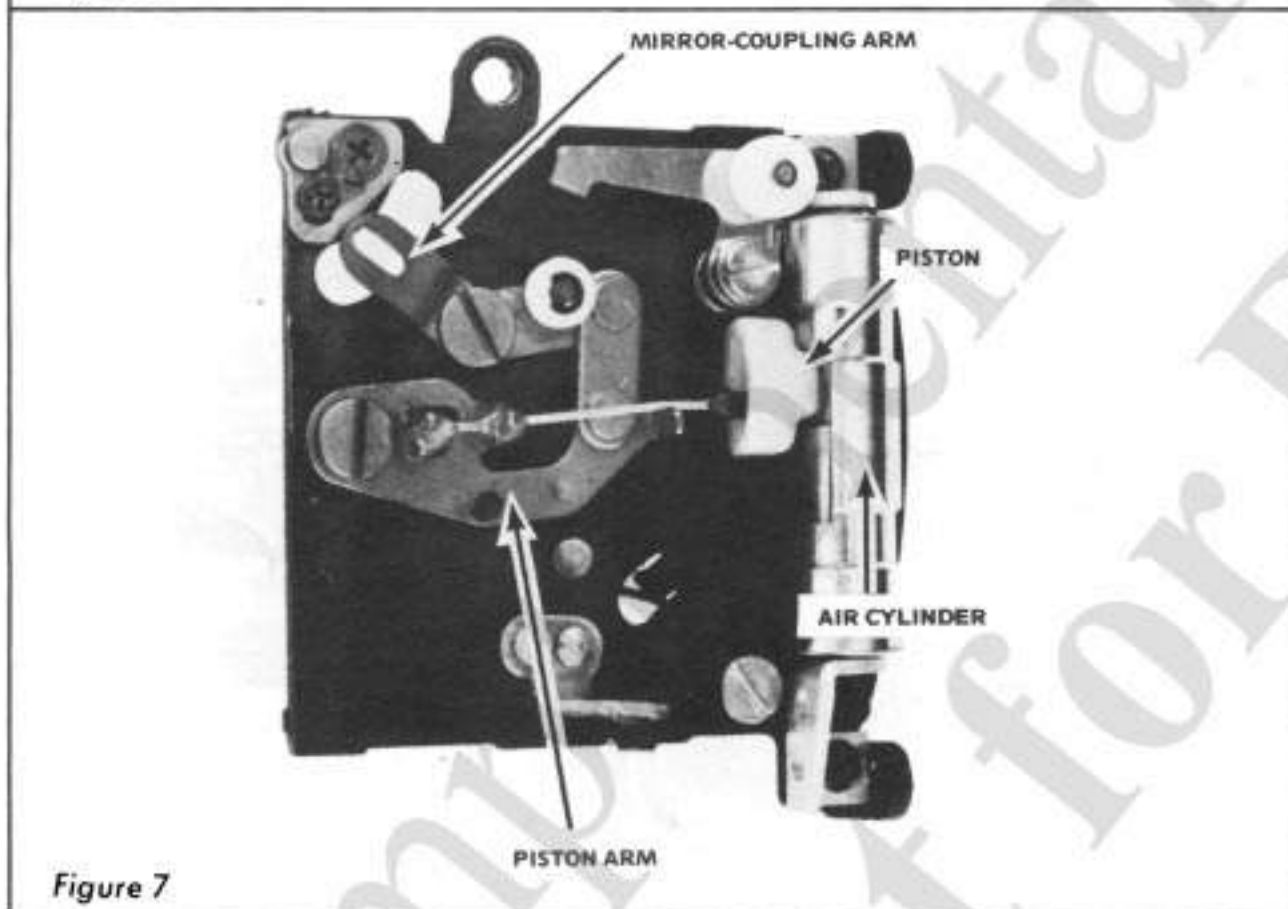

Figure 7

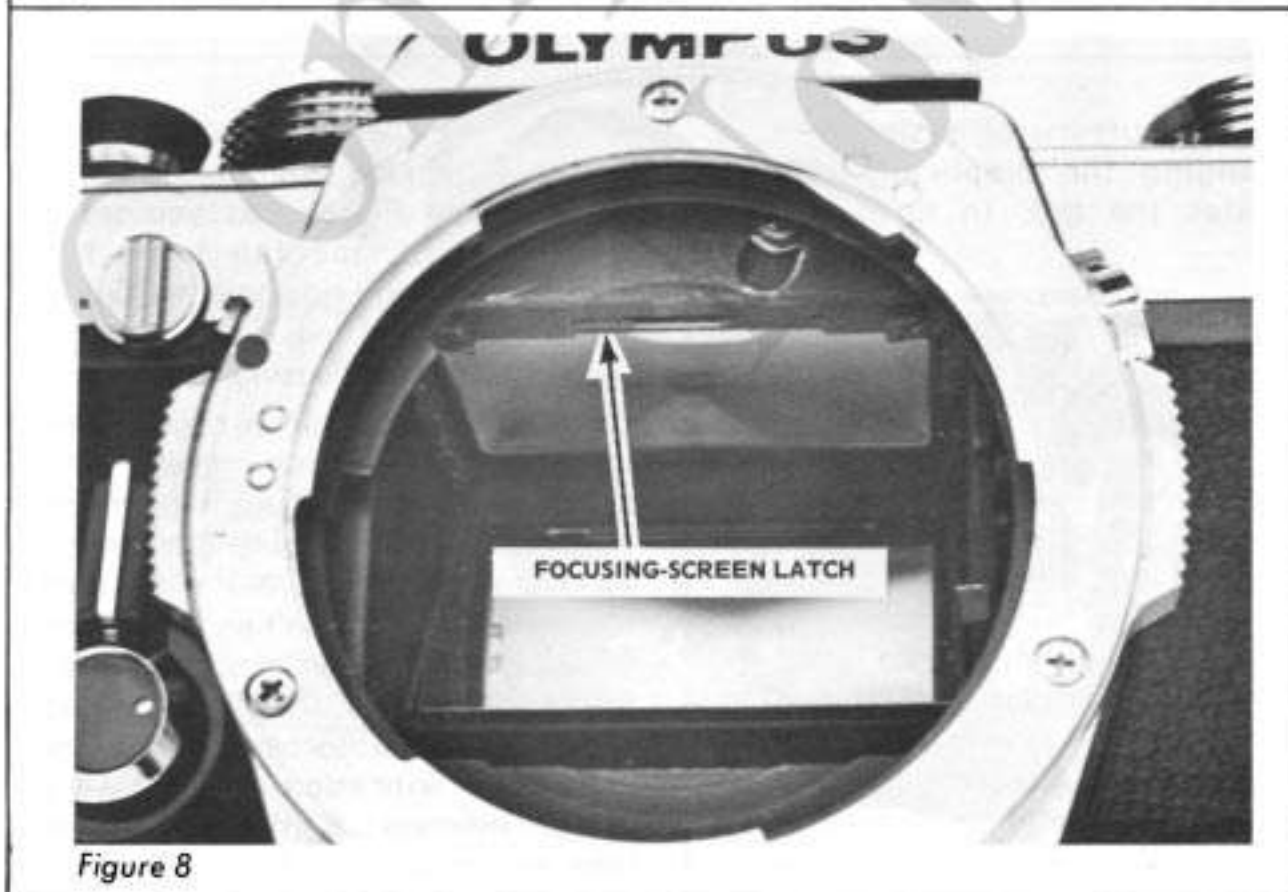

Figure 8

Fig. 7 shows the mechanism side of the mirror-cage wall, the side that faces the wind-lever end of the camera. The mirror cage and the front plate come out of the camera as a unit (a procedure we'll later discuss). But the mirror cage itself comes out in sections rather than as an assembly, another OM-1 design twist.

The slot in the mirror-coupling arm fits over a pivot on the mirror-mounting plate. As the mirror moves up, the mirror-coupling arm drives the piston arm toward the bottom of the mirror cage. Returning to the viewing position, the mirror lifts the piston arm to the position shown in Fig. 7. So the piston arm always moves with the mirror; and the piston arm carries the piston, traveling within the tight-fitting air cylinder.

The air-damping piston, along with a unique braking system for the curtains, almost eliminates the vibrations one might expect in such a tiny SLR. In larger SLR's, the size itself may be sufficient to soak up problem-causing vibrations. But, thanks to thoughtful design, the small size of the OM-1 appears to be no handicap in this area.

#### Other Features of The OM-1

We mentioned that the OM-1 offers several interchangeable focusing screens. Yet the pentaprism can't be removed (that is, until you disassemble the camera). So it first appears that replacing the focusing screen requires partial camera disassembly.

But all you have to do is remove the lens — the focusing screen comes out from the bottom. Locate the focusing-screen latch, Fig. 8. Using your tweezers or a small screwdriver, push the focusing-screen latch toward the front of the camera (Olympus provides a special "pick" with the focusing screens). The hinged focusing-screen tray now swings down, as shown in Fig. 9.

The tab on the Fresnel lens bears a number identifying the style. When you replace the Fresnel lens, make sure that the number is up (toward the top of the camera). The tab then fits into a slot formed in the focusing-screen tray.

There are only two calibrations on the focusing screen — a "+" (overexposure) and a "-" (underexposure). Unlike so many of its contemporaries, the OM-1 does not

reveal diaphragm settings or shutter-speed settings through the finder. But even though you may miss these features, you'll appreciate the exceptionally bright focusing-screen image. Here, the OM-1 is in a class by itself.

The through-the-lens exposure meter takes its readings from the entire focusing-screen area. However, it appears the designers were most concerned with scenics shot on a horizontal format — the angle of the CdS cells favors the lower, central portion of the picture area.

Turn the exposure meter on or off with the switch at the top of the camera, Fig. 2. Since the exposure-meter switch is completely independent of the shutter or wind lever, you can take a reading whenever you want. Power for the CdS exposure meter comes from a single mercury cell, 625 or 625R, housed at the bottom of the camera.

Another switch controls the sync delay. There's just one sync terminal for both "FP" and "X" sync; the sync terminal sits right in the middle of the sync-selector switch, Fig. 4. The setting of the sync-selector switch determines whether or not the FP-sync contacts are electrically connected to the flash circuit.

"X" sync is also delivered at the hot-shoe connector, Fig. 2. Strange — there's no accessory shoe, but there is provision for firing a cordless electronic flash. The solution to what may seem a mystery is that the hot shoe is detachable. Making the hot shoe an accessory is yet another novel approach toward reducing the camera's dimensions.

The remaining external features are pretty standard. Open the camera back by pulling up the rewind knob (a not-so-standard feature is that you can completely remove the camera back — just push down the pin that extends from the back hinge). To disengage the sprocket prior to rewinding the film, turn the sprocket release, Fig. 1, in a counterclockwise direction. The delayed-action release lever is underneath the delayed-action cocking lever, a typical location. But the delayed-action release lever sits very close to the camera body; you may find it somewhat inconvenient to operate.

### Design Originality At The Bottom of The OM-1

The curtain-wind and mirror-cocking mechanisms on the bottom of

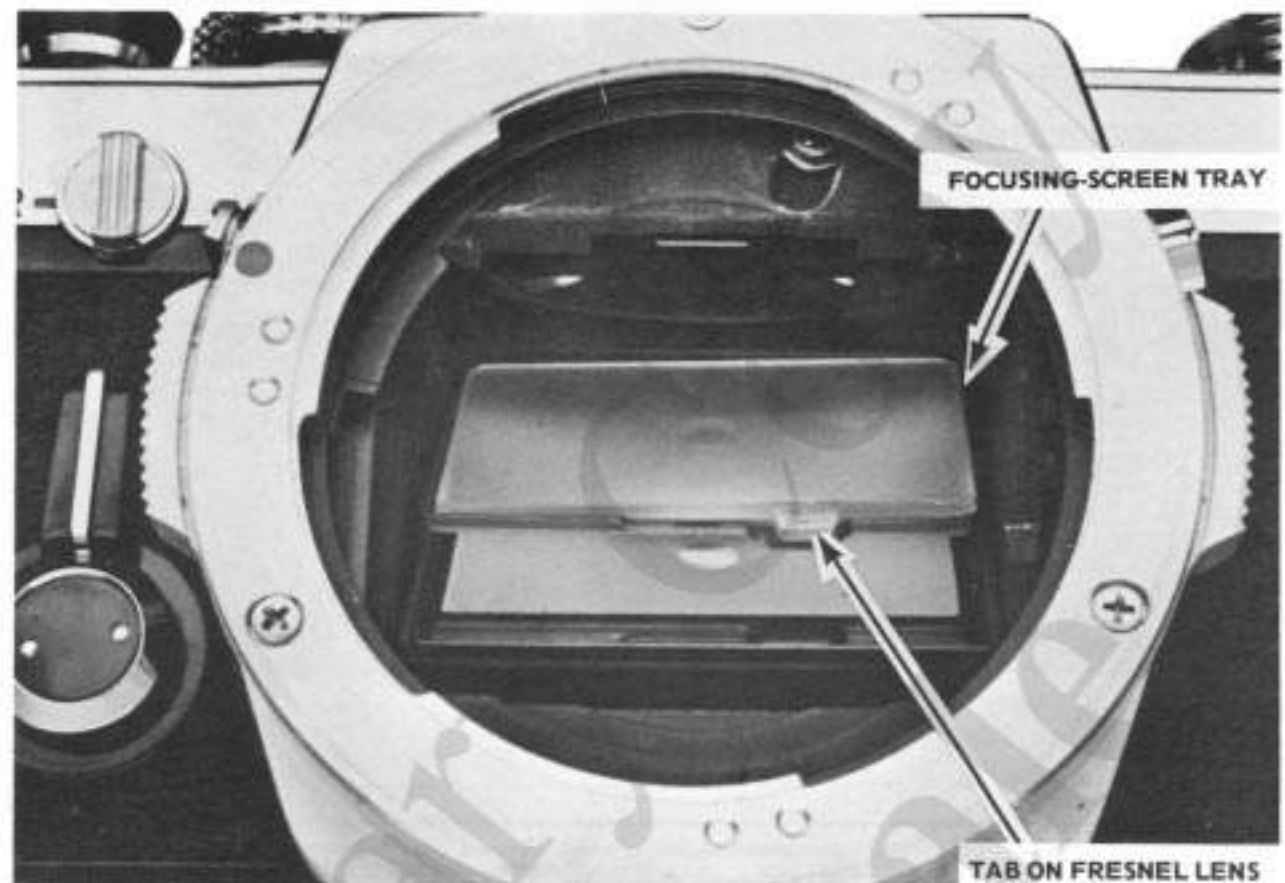

Figure 9

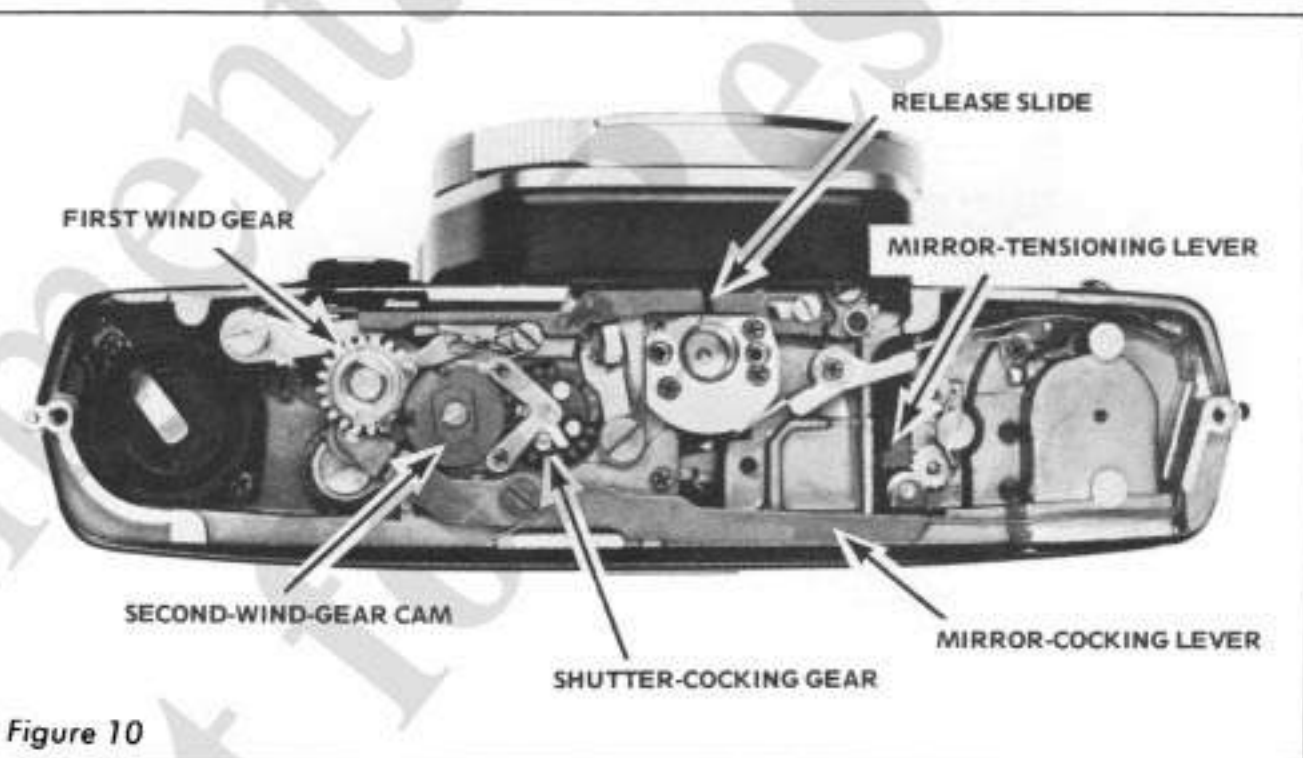

Figure 10

the OM-1 display Olympus' unique approach to a conventional shutter. At first glance, the OM-1 appears to house a drum-type shutter, Fig. 10. But there's no curtain drum under the curtain-wind gears; rather, there's a novel approach to double-roller design.

Remember that the opening and closing curtain wind gears are at the bottom of the camera. You can see the closing-curtain wind gear in Fig. 3; the opening-curtain wind gear is underneath the closing-curtain wind gear. A pair of interlocking studs — one on the opening-curtain wind gear and one on the shutter-cocking gear, Fig. 10 — engage during the wind cycle to advance the curtains.

In Fig. 11, we have removed the shutter-cocking gear just to point out the interlocking studs. As the shutter-cocking gear turns counterclockwise, its stud engages the stud on the opening-curtain wind gear. The opening-curtain wind gear then turns the opening-curtain winding roller, drawing the opening curtain to the tensioned position. Simultaneously, through another set of interlocking studs, the opening-curtain wind gear turns the closing-curtain wind gear; that winds on the closing curtain.

As you cock the shutter, you'll notice the exceptionally smooth wind-lever stroke. Part of the credit goes to the first wind gear, Fig. 10. The first wind gear, responsible both for

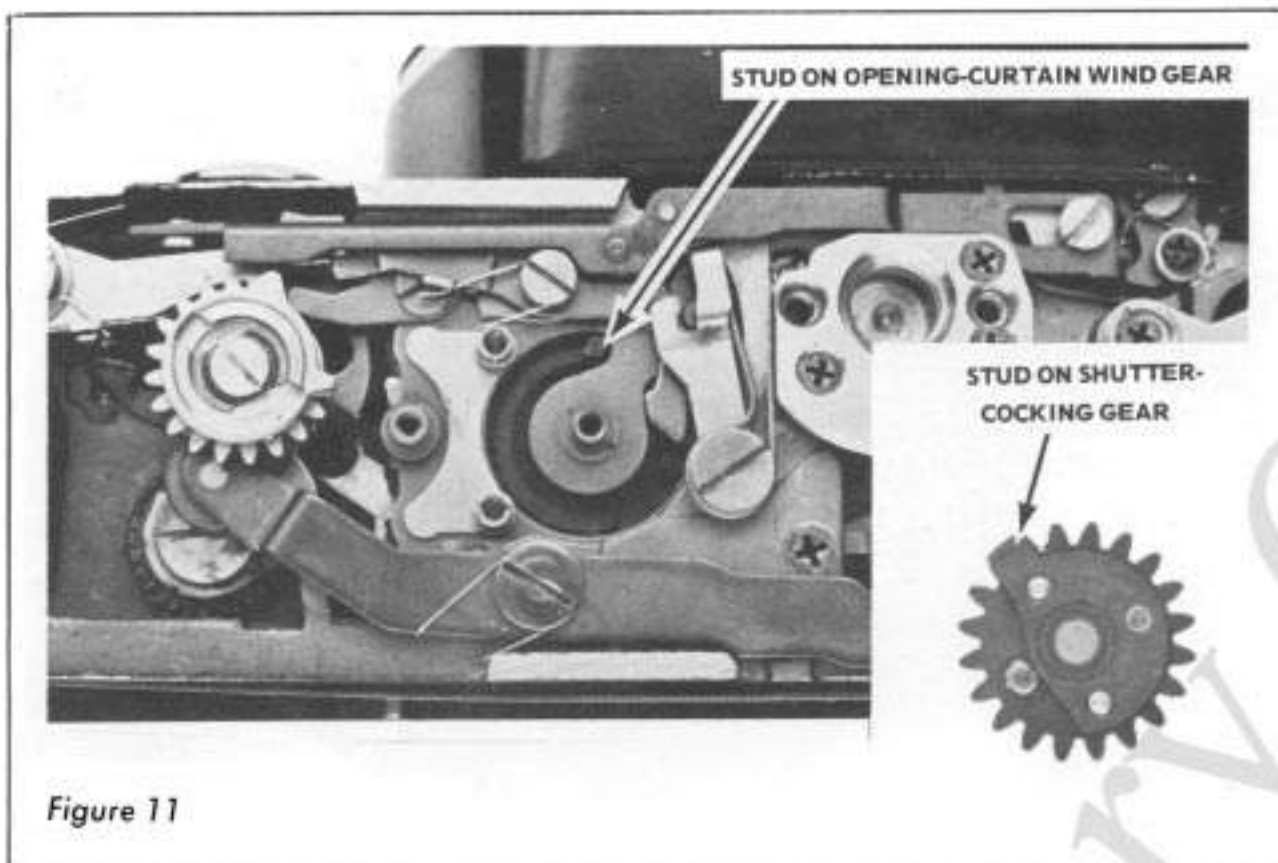

Figure 11

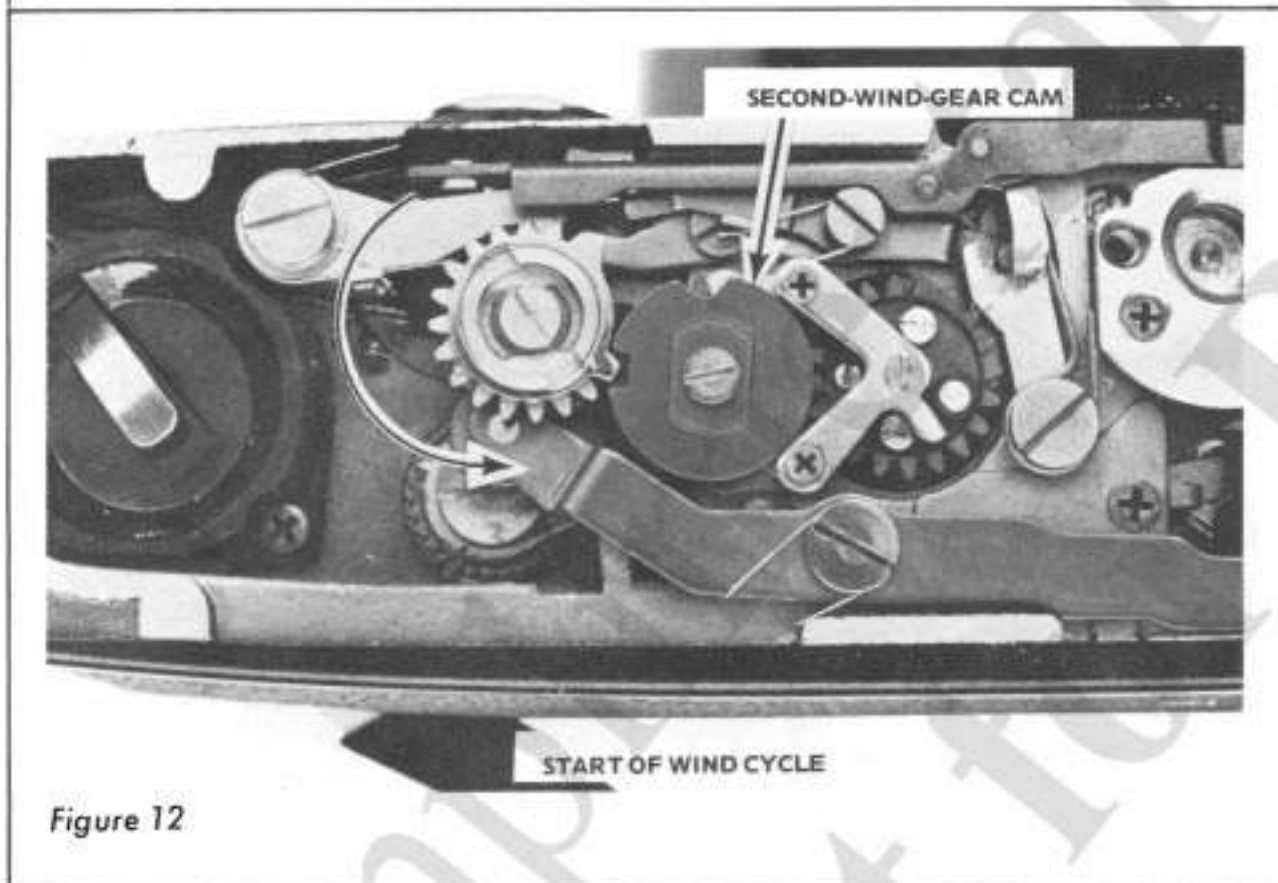

Figure 12

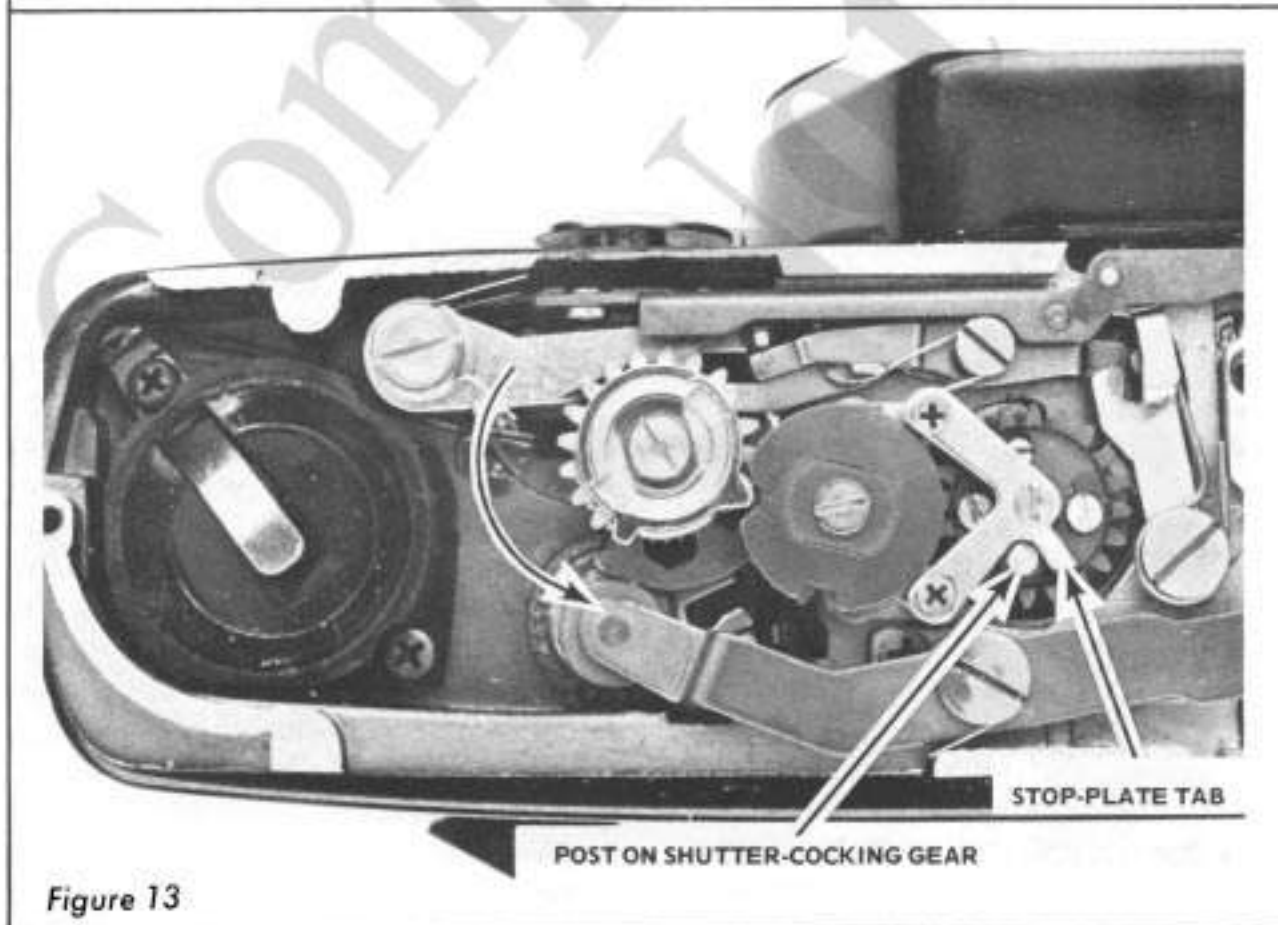

Figure 13

cocking the shutter and for tensioning the mirror, runs on ball bearings. The two curtain-wind gears, Fig. 3, also glide silently on ball races.

You can now follow the cocking sequence at the bottom of the camera. Advancing the wind lever turns the first wind gear counterclockwise. At the start of the rotation, a lug on top of the first wind gear passes into a notch in the second-wind-gear cam, Fig. 12. The lug pushes the second wind gear clockwise — until the teeth of the first wind gear engage the teeth of the second wind gear (underneath the cam). This initial push is necessary because the teeth of the first wind gear are cutaway, clearing the second wind gear in the shutter-released position.

The first wind gear now turns the second wind gear clockwise. And the second wind gear turns the shutter-cocking gear to advance the curtains. Toward the end of the cocking cycle, a second lug atop the first wind gear engages another notch in the second-wind-gear cam, Fig. 13. The lug pushes the second wind gear slightly further in a clockwise direction, until the curtains latch in the "ready" position. At the same time, the teeth of the first wind gear disengage from the second wind gear.

That final push brings the post atop the shutter-cocking gear against the tab of the stop plate, Fig. 13. The action then becomes a little difficult to follow. As you watch the shutter-cocking gear, the post appears to pass underneath the stop-plate tab. Suddenly, it turns up on the other side, Fig. 14.

But it's just an illusion — there's no way the post could pass underneath the stop-plate tab. Once the first wind gear disengages from the second wind gear, the shutter-cocking gear spins clockwise. The second wind gear is spring-loaded. So, once it's free of the first wind gear, the second wind gear returns the shutter-cocking gear to the starting position — against the stop-plate tab. It's all so fast that your eye can barely follow the action.

This unique curtain-wind system eliminates the need for a separate gear-train release. The curtains are now ready to fire. Since the shutter-cocking gear has returned to the starting position, its stud no longer engages the stud on the opening-curtain wind gear. Consequently, only the opening-curtain latch holds the curtains tensioned.

The opening-curtain latch is another part that's pretty well hidden from view. So in Fig. 15, we have removed both the shutter-cocking gear and the tripod socket to point out the opening-curtain latch. Here, you can see that one end of the opening-curtain latch engages the opening-curtain wind gear; the other end sits alongside the opening-curtain release lever.

Pushing the opening-curtain release lever against the opening-curtain latch releases the shutter. The part that actuates the opening-curtain release lever is the opening-curtain striker, a mirror-cage component. You can just see the end of the opening-curtain striker in Fig. 16.

As the mirror rises to the taking position, the opening-curtain striker swings toward the back of the camera — against the opening-curtain release lever. Now, the opening curtain crosses the focal-plane aperture; the closing curtain remains latched for the desired exposure time.

Referring back to Fig. 11, notice that the stud on the shutter-cocking gear is actually part of a plate — a plate that's mounted to the underside of the shutter-cocking gear. Two brass screws on top of the shutter-cocking gear hold the plate in position. Both screw holes in the shutter-cocking gear are elongated. So, by loosening the screws and turning the eccentric, Fig. 14, you can shift the plate.

Making the plate a separate piece provides an overtravel adjustment for the opening-curtain latch. That is, the opening-curtain wind gear travels slightly further than necessary for the opening-curtain latch to engage; this overtravel assures a positive latching action.

You can check the overtravel by slowly advancing the wind lever. As you approach the end of the cocking cycle, watch the tail of the opening-curtain latch — it's visible even with the tripod socket in place, Fig. 14. Stop advancing the wind lever when you see the opening-curtain latch drop into engagement with the opening-curtain wind gear. Then, continue advancing the wind lever while watching the post on the shutter-cocking gear. The post should travel slightly further in a counterclockwise direction (around 0.3mm) before the shutter-cocking gear flips back to its starting position.

(continued page 24 )

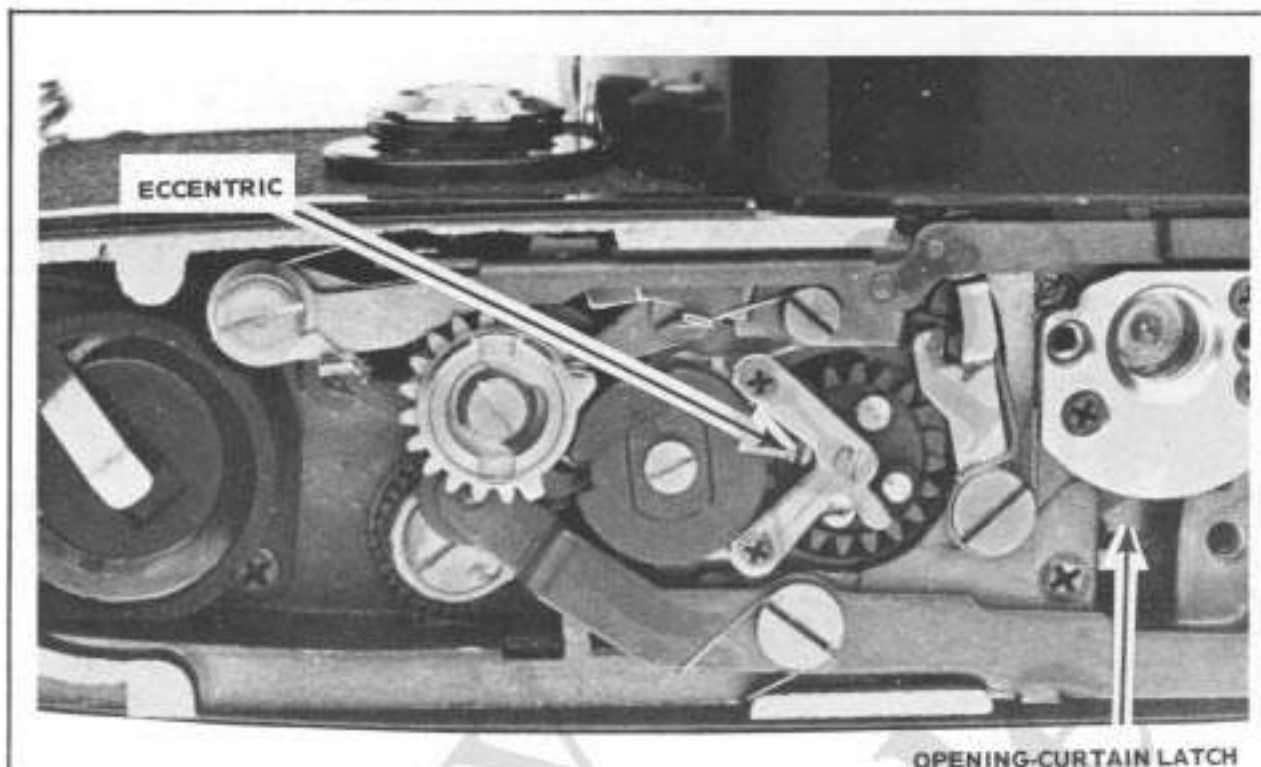

Figure 14

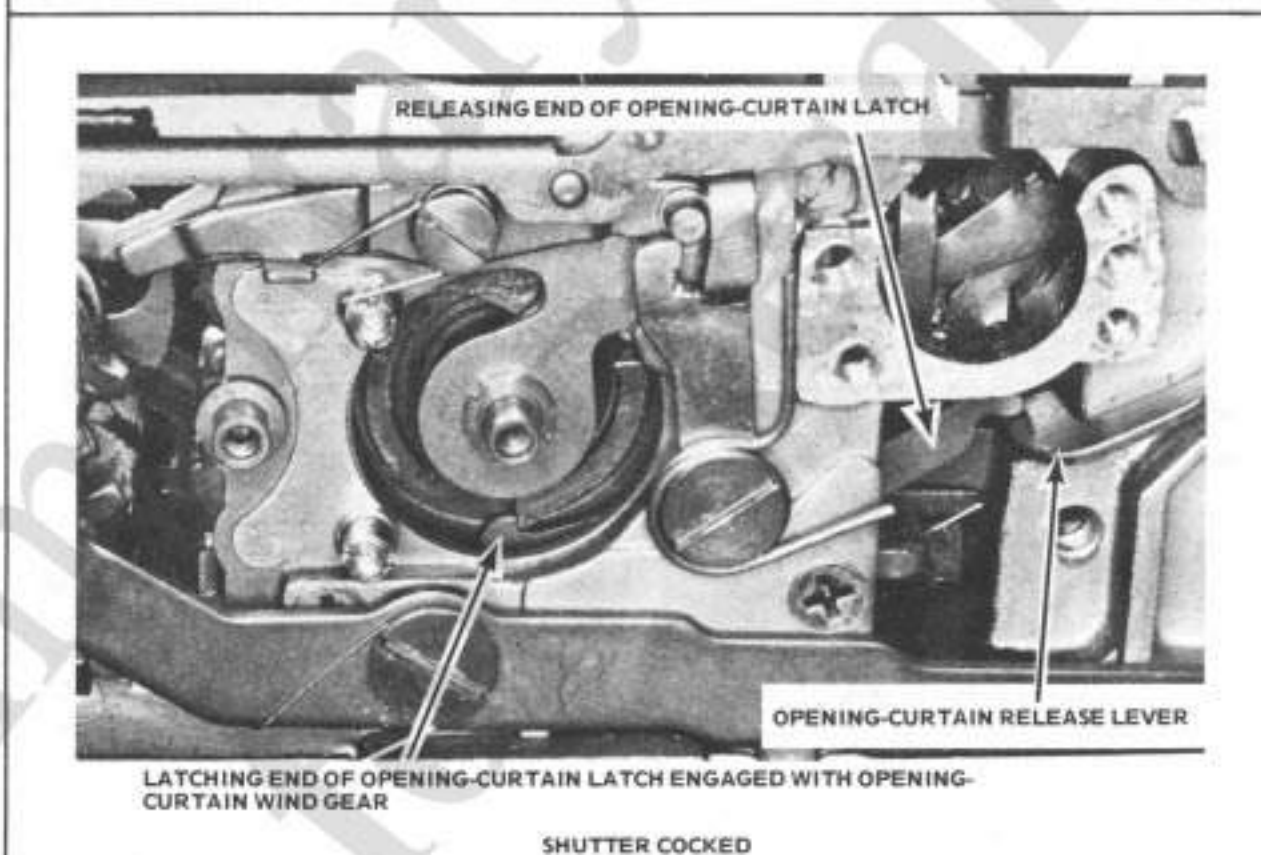

Figure 15

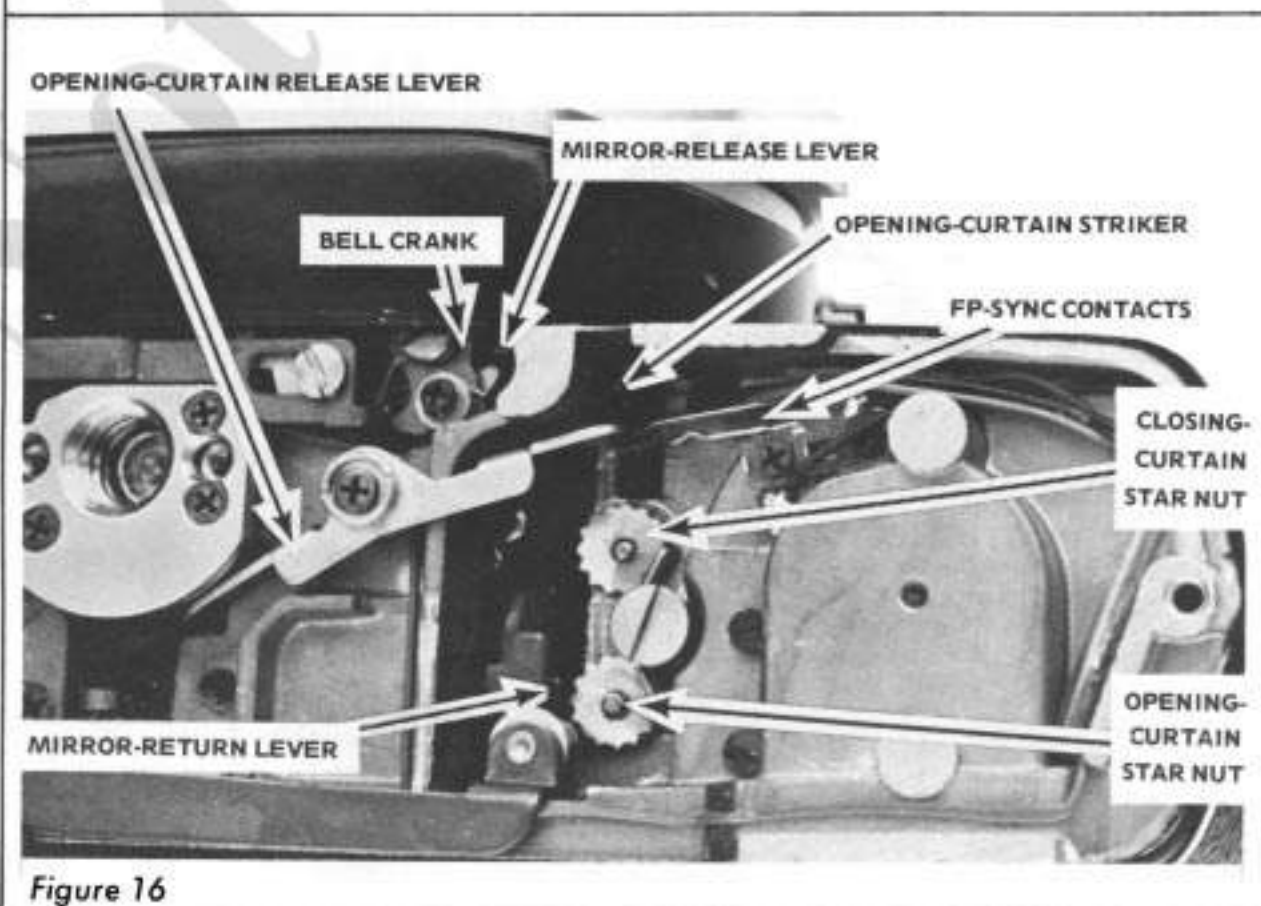

Figure 16

# OLYMPUS OM-1

(from page 9)

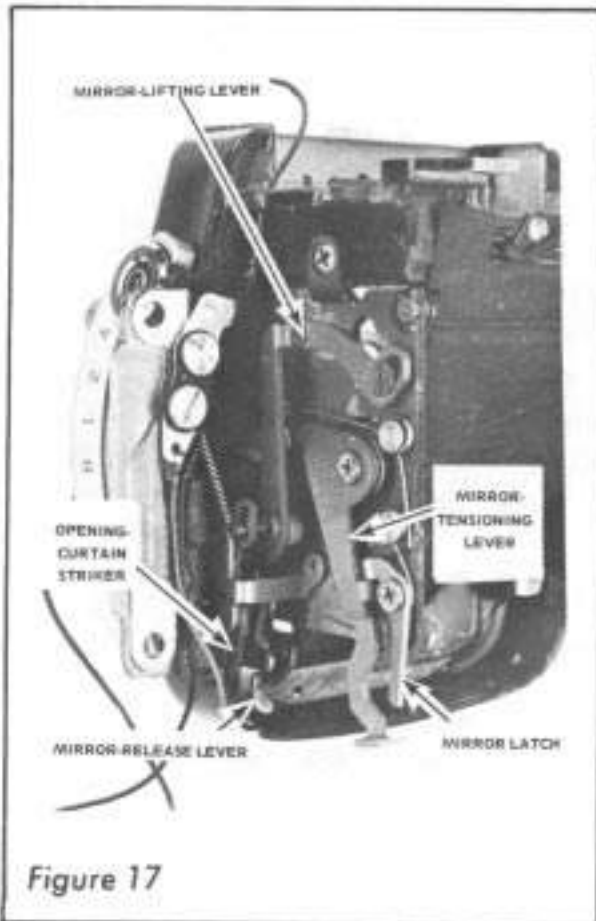

Figure 17

## Mirror Cocking And Release

Cocking the shutter simultaneously tensions the mirror. A cam underneath the first wind gear comes against a roller attached to the mirror-cocking lever, Fig. 10. A roller at the other end of the mirror-cocking lever then drives the mirror-tensioning lever toward the front of the camera.

The mirror-tensioning lever and three other mirror-cage components pass through cutouts in the bottom of the camera. They're a little difficult to identify in the illustrations. But you can see what the parts look like in Fig. 17, showing the side of the mirror cage (the opposite side from Fig. 7). The mirror-tensioning lever, the opening-curtain striker, the mirror latch, and the mirror-release lever are all visible (barely) at the bottom of the camera.

As the mirror-tensioning lever moves toward the front of the mirror cage, it tensions the mirror-lifting spring — that's the spring which will later lift the mirror to the taking position. The mirror latch then engages the mirror-tensioning lever.

Depressing the release button moves the release slide from left to right, Fig. 10. The right-hand end of the release slide pushes the bell crank against the end of the mirror-release

lever; Fig. 16 and Fig. 17 both point out the mirror-release lever. Now, the mirror-release lever disengages the mirror-lifting lever. And the mirror-lifting lever drives the mirror to the taking position.

Notice the eccentric adjustment on the bell crank. The bell crank is in two sections — one section contacts the mirror-release lever and the other section is engaged by the release slide. The adjustment determines how far you depress the release button before disengaging the mirror. Check the adjustment by first cocking the shutter; then, slowly depress the release button. The end of the screw slot in the release slide should just about reach the screwhead — within half a millimeter — when the mirror releases.

As the mirror-lifting lever raises the mirror, it also drives the opening-curtain striker toward the back of the camera. The opening-curtain striker has a couple of duties. Besides releasing the opening curtain, it closes the FP-sync contacts, Fig. 16. The contact-closing function explains why there's an insulator sleeve over the end of the opening-curtain striker.

The mirror remains latched in the taking position until the closing curtain crosses the focal-plane aperture. Then, the closing-curtain wind gear pushes the mirror-return lever against the mirror latch. (You can just see the end of the mirror-return lever in Fig. 16.) In turn, the mirror latch frees the mirror-tensioning lever, allowing the mirror to return to the viewing position.

## Removing The Top Cover — Timing Between The Galvanometer And The Film Speed Knob

Although the OM-1 uses a mechanical-coupling system for the exposure meter, the timing for the top cover is exceptionally straightforward. For one thing, you don't have to worry about the shutter-speed coupling when removing the top cover — that's because the shutter-speed-setting ring is behind the lens mount. So the only timing of concern is that between the film-speed knob and the galvanometer.

Even here the timing is convenient. Notice that certain key film speeds on the film-speed knob are in yellow. These film speeds match scribe lines placed on top of the galvanometer.

A slot on the underside of the film-speed knob straddles the tab shown in Fig. 18; the tab is part of the film-speed cam on top of the galvanometer. Turning the film-speed knob rotates the film-speed cam. And the film-speed cam positions the galvanometer housing.

Each scribe line on the film-speed cam corresponds to a film speed — a film speed calibrated in yellow

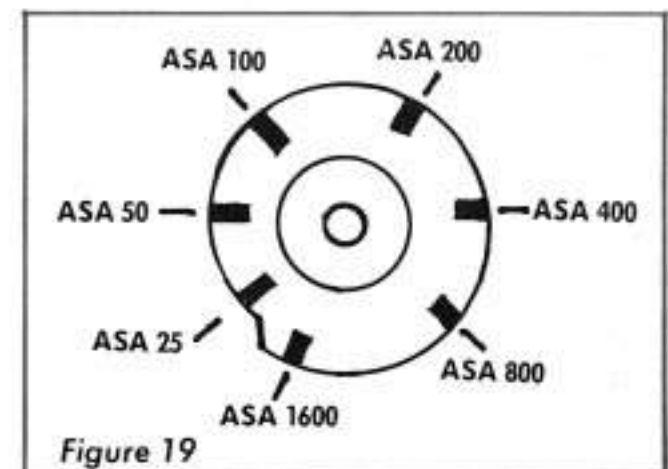

Figure 19

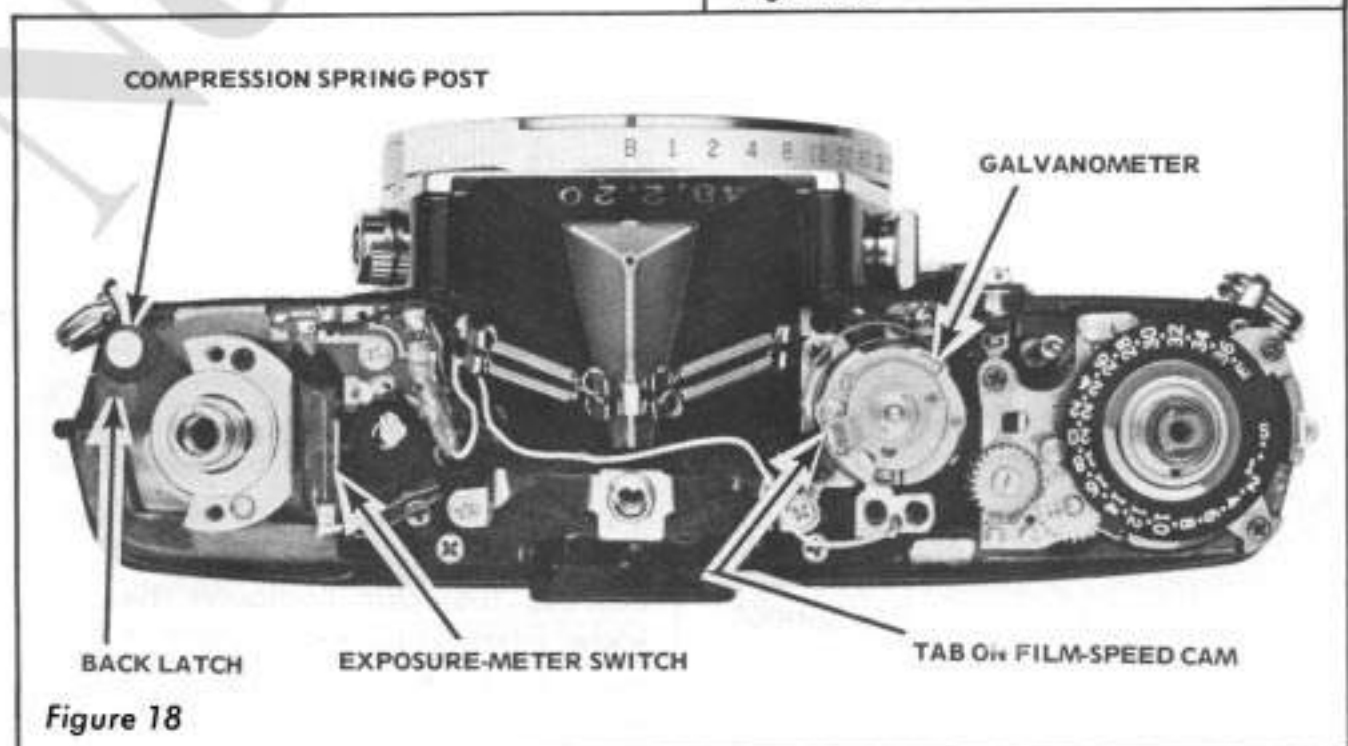

Figure 18

numbers on the film-speed knob. Fig. 19 shows the film-speed setting indicated by each scribe line. On reassembly, all you have to do is turn the film-speed cam until one scribe line points to the cam follower, Fig. 20. Then, set the matching film speed on the film-speed knob.

The calibrations on the film-speed cam eliminate any timing worries on disassembly. That leaves only one trick in the removal of the top cover. The black decorative cap atop the wind lever has two spanner holes. And it looks as though all you have to do is unscrew the decorative cap with your Multispan wrench.

The rub is that the decorative cap is cemented to the wind-lever retaining screw. There are also two spanner holes in the wind-lever retaining screw — but these spanner holes don't align with the spanner holes in the decorative cap.

However, using your Multispan wrench, you can rotate the decorative cap. Turn the decorative cap until its spanner holes align with the spanner holes in the wind-lever retaining screw. Then, unscrew the wind-lever retaining screw and remove the wind lever.

Also remove the retaining ring under the wind lever, the rewind knob, and the two screws under the rewind knob. Both the film-speed knob and the exposure-meter switch remain with the top cover.

There're no wires to disconnect when removing the top cover. But one spring is loose. The compression spring sits over a post, Fig. 18, on the back latch. When you lift the rewind knob to open the back, the compression spring pushes against the top cover. The compression spring then gives the back latch an extra push on the return stroke.

### Exposure-Meter Coupling in The OM-1

From the top of the camera, Fig. 18, you see very little of the cross-coupling system. The two rings that control the galvanometer's position are behind the lens-mounting ring. And the cord that couples the two rings to the exposure-meter system hooks to a spring-driven disc underneath the galvanometer.

Fig. 21 shows the first of the two coupling rings. Here, we have removed the lens-mounting ring and the shutter-speed-setting ring. (When removing the shutter-speed-setting

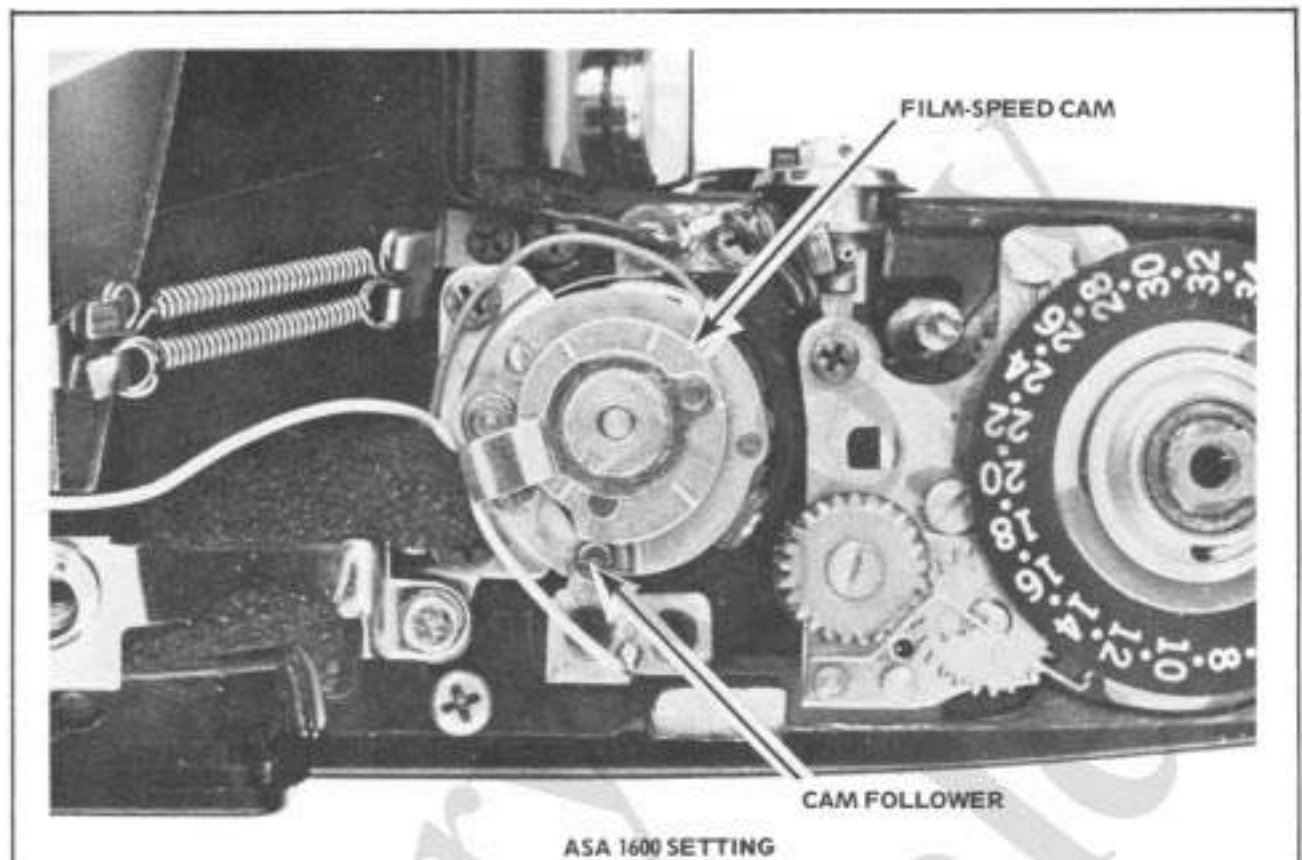

Figure 20

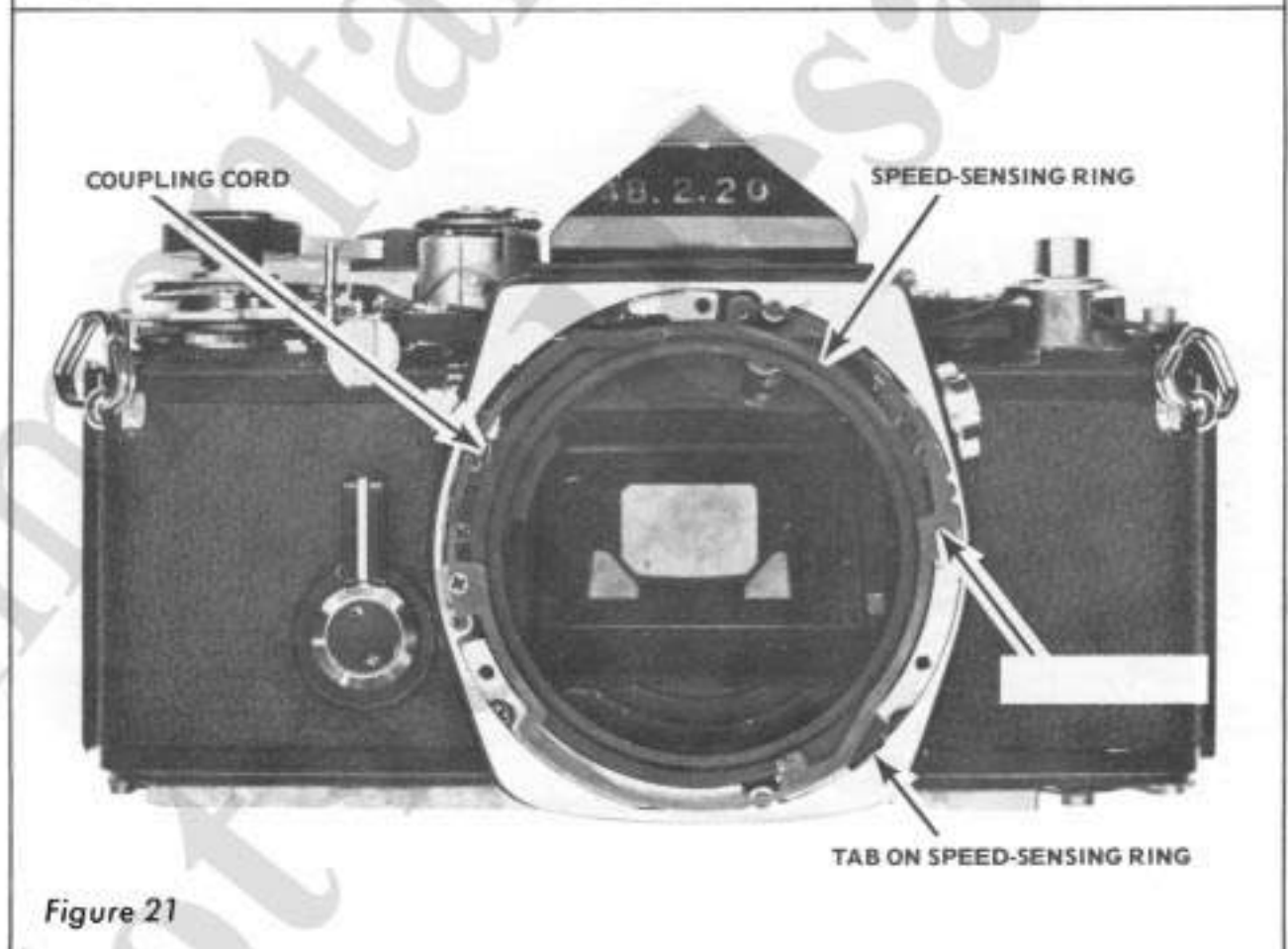

Figure 21

ring, watch for the ball detent that provides the click-stop shutter-speed settings.) The coupling ring now revealed is the **speed-sensing ring**.

A tab extending from the speed-sensing ring passes into a slot in the shutter-speed-setting ring. So turning the shutter-speed-setting ring rotates the speed-sensing ring. Barely visible in Fig. 21 is the coupling cord, cemented within a groove in the outside circumference of the speed-sensing ring.

Besides signaling the exposure-meter system, the speed-sensing ring also sets the shutter speed. A row of teeth on the inside surface of the speed-

sensing ring engages the speed-control gear — that's the gear which carries the speed-control cam stack mentioned earlier (Fig. 3). In Fig. 21, the speed-sensing ring is at the "bulb" setting; notice that we've turned the speed-sensing ring as far as it can go in a counterclockwise direction. Turning the speed-sensing ring all the way clockwise sets the shutter — and the galvanometer — to the 1/1000-second setting.

Before removing the speed-sensing ring, set the shutter to 1/1000 second — just turn the speed-sensing ring all the way clockwise. Then, remove the spring plate, Fig. 21, by taking out its

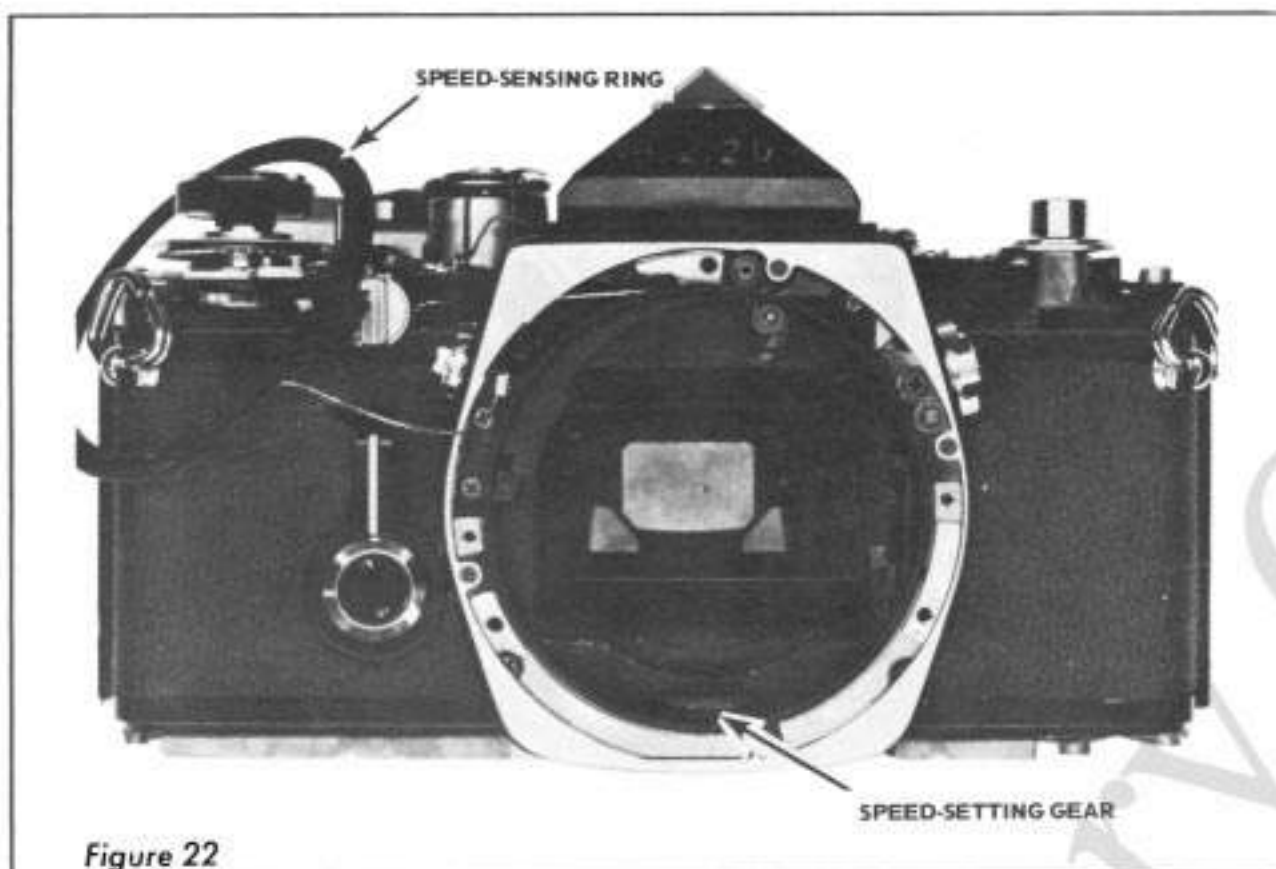

Figure 22

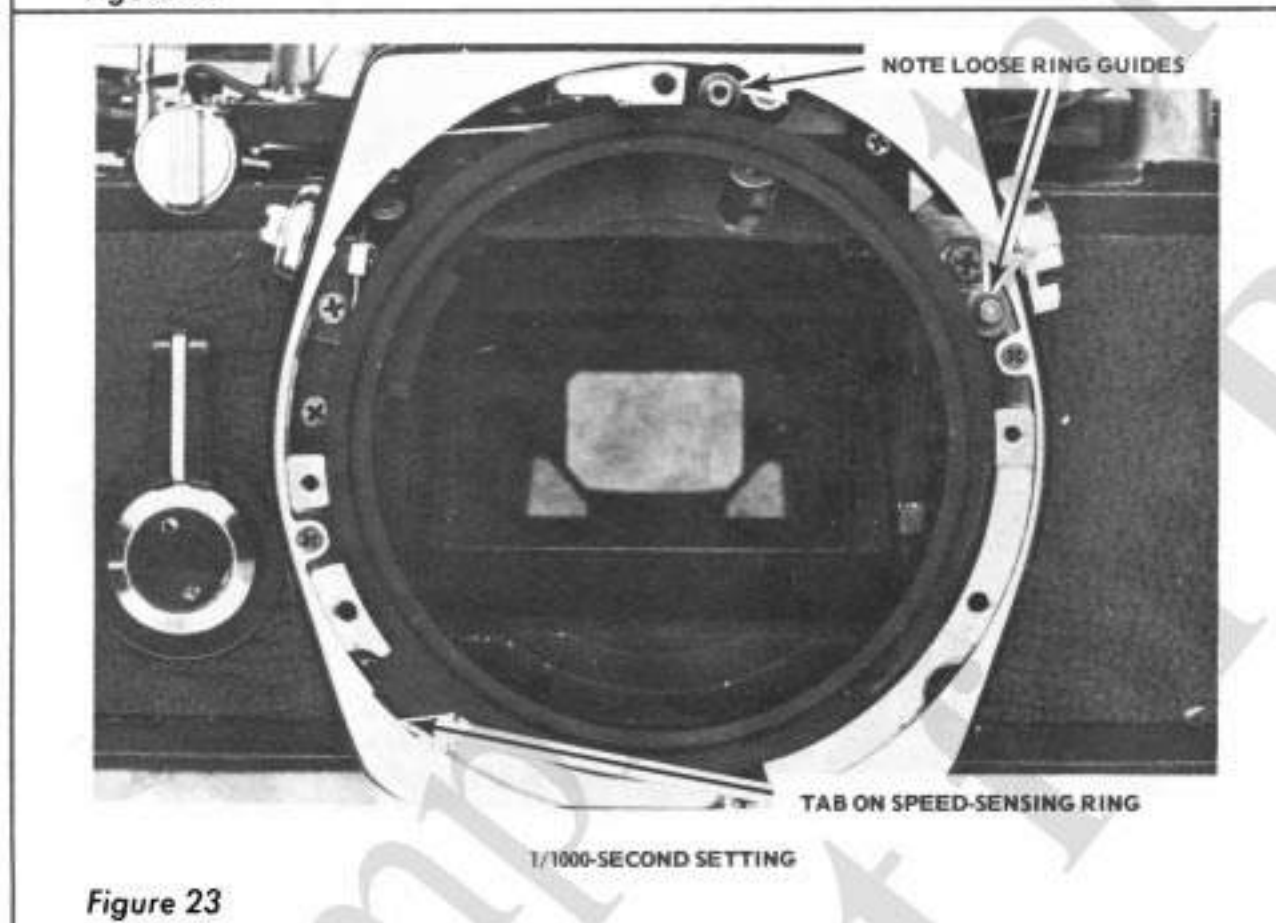

Figure 23

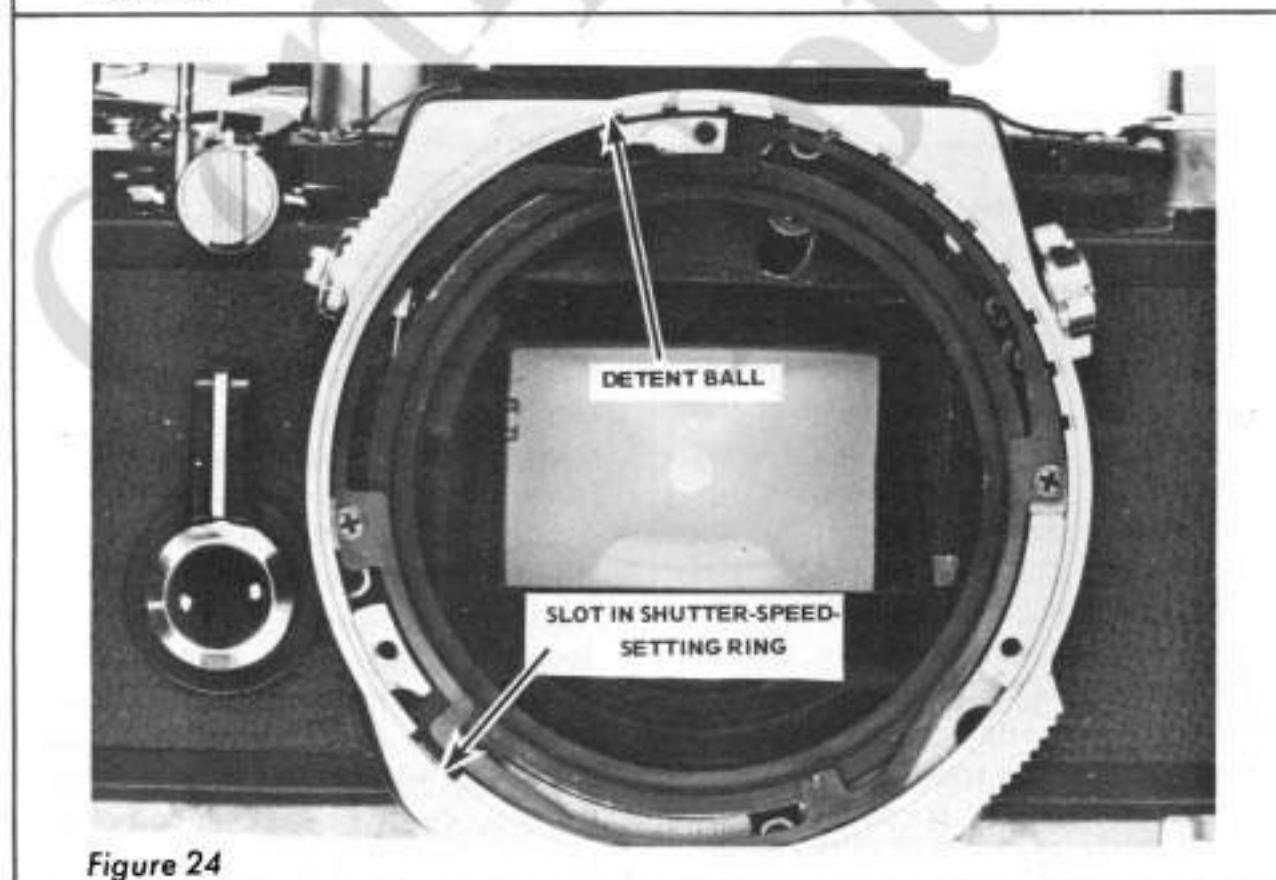

Figure 24

two screws. You can now lift aside the speed-sensing ring; the cord remains attached, Fig. 22.

Be careful to avoid turning the speed-setting gear, Fig. 22. It's now at the 1/1000-second setting. On reassembly, replace the speed-sensing ring as shown in Fig. 23, with its tab against the lug on the front plate. Then, after replacing the spring plate and the ball detent, seat the shutter-speed-setting ring — the slot in the shutter-speed-setting ring straddles the tab on the speed-sensing ring, Fig. 24.

The reassembly gets a little more complicated when the speed-setting gear turns to some position other than 1/1000 second. Then, it's pretty tricky to find a precise shutter-speed setting.

Olympus does, however, provide a special timing mark on the speed-setting gear. A hole passing through the speed-setting gear marks the 1/1000-second setting. When the timing hole faces the front of the camera, the shutter is at 1/1000 second. But it's quite difficult (though not impossible) to see the timing hole at this stage of disassembly.

Fig. 25, at a later stage of disassembly, shows the 1/1000-second timing hole. The shutter speed is now set to 1/1000 second — notice the position of the timing hole, toward the front of the camera. When you now install the speed-sensing ring at the 1/1000-second position, the speed-setting gear is properly timed.

Lifting out the speed-sensing ring also reveals the aperture-sensing ring, Fig. 26. There's another coupling cord hooked to the aperture-sensing ring, following within a track in the ring's outer circumference. This cord passes through a cutout in the front plate.

At the back of the front plate, the aperture-sensing-ring cord wraps around a suspended pulley, Fig. 27; only a spring holds the pulley in place. Once around the pulley, the cord proceeds to the top of the front plate where it wraps three times around a lug. As you set a larger f/stop, the cord pulls up the pulley. And the pulley, moving toward the top of the camera, adds tension to the spring. Setting a smaller f/stop allows the spring to pull the pulley toward the bottom of the camera.

For all its undulating route, the aperture-sensing-ring cord has only one purpose — it couples the aperture-sensing ring to the spring. And the spring provides the tension which

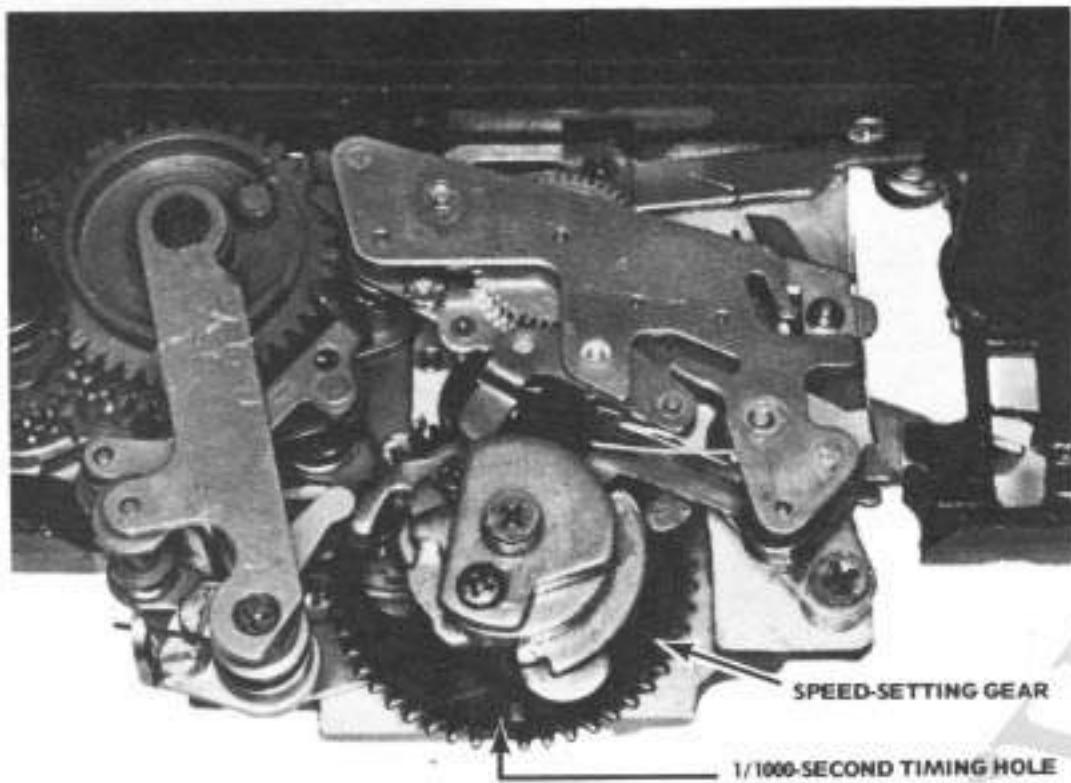

Figure 25

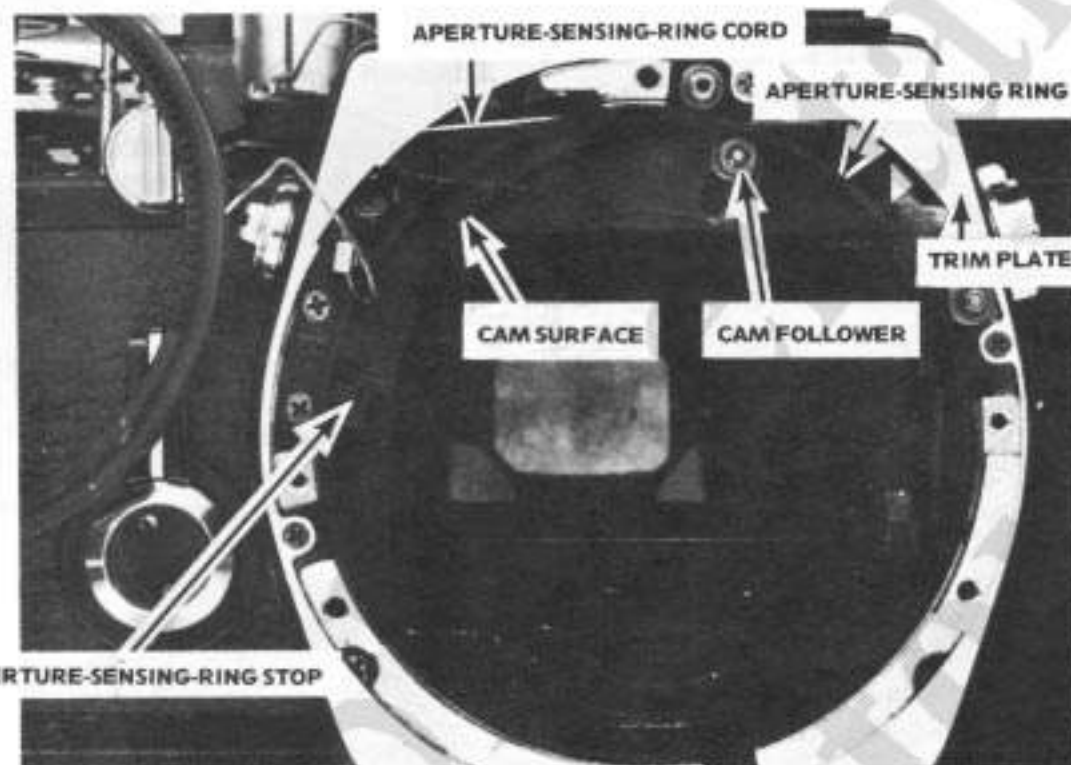

Figure 26

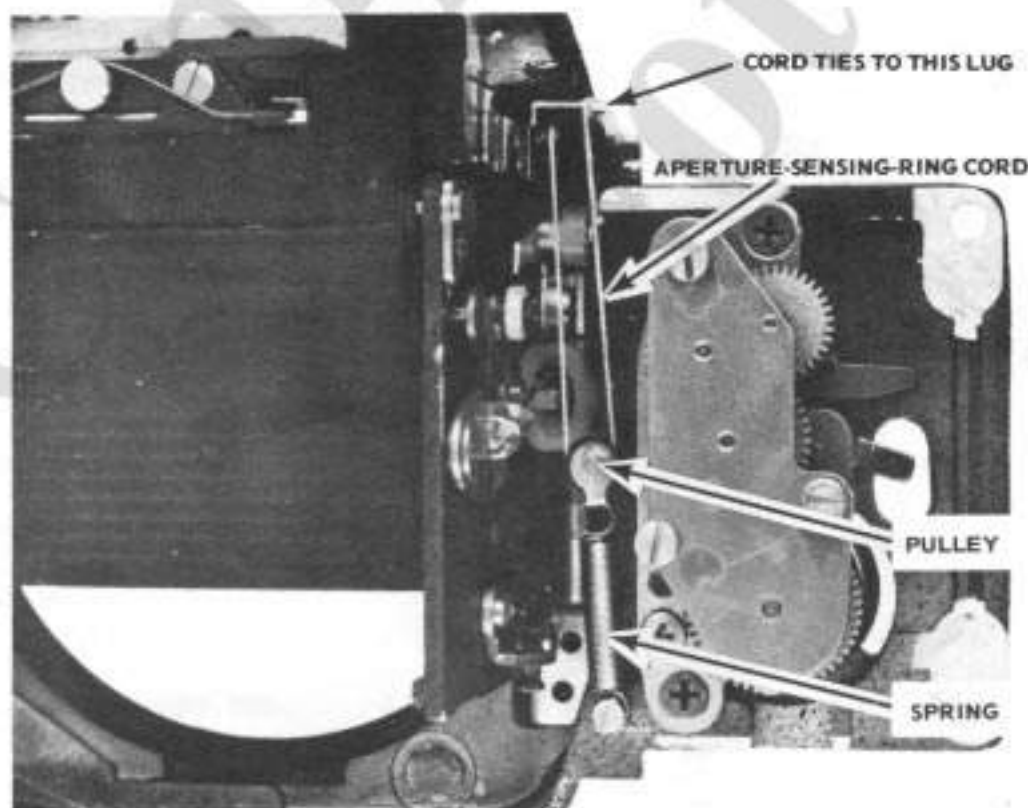

Figure 27

## A HIT WITH EVERYONE WHO'S TESTED IT... NEW CONCEPT IN SOLDERING IRONS



### CORDLESS AND RECHARGEABLE

Instant safe operation — truly impressive performance. Heats in only 3 to 5 seconds for instant use, recharges automatically in stand. Makes difficult jobs easy at the bench or on the job — lightweight and tiny to slip in tool kit or pocket. No drop cords to string — no need to search for a power source.

Easily replaced tips designed to eliminate electrical leakage, the need for grounding and the possibility of damage to sensitive electronic components. Tiny tips are only hot when in use hence long-lived. Pushbutton operation — built-in work and pilot lights. When not in use store in charger stand. Built-in long-life nickel-cadmium cells. Ideal for camera repairs, radio, TV and aircraft servicemen, hobbyists, electronic laboratories, printed circuit work. Lightweight — less than 6 oz. Only 8" l. Kit includes Cordless Iron, separate Recharging Stand, 1 each regular and fine tips, 6' coil of 60/40 resin core solder and instructions. 1 year guarantee.

NC No. I-5195		\$24.95
Replacement Tips		
NC No. T-3670	Regular	\$2.00
NC No. T-3671	Fine	\$2.50

## Illuminating Magnifier



with 2" x 4" Lens

- STRONG, TOUGH, DURABLE PLASTIC.
- FLOODLIGHTS MAGNIFIED AREA
- REVERSIBLE LIGHT REFLECTOR
- DETACHABLE CORD.
- MODERN DESIGN
- CORNING OPTICAL GLASS POLISHED TO OPTICAL STANDARDS.

NC No. M-0287  
\$12.95



**National Camera**  
2000 West Union Ave.  
Englewood, Colorado, 80110

GREAT NEW FINDS FOR YOUR WORKSHOP GREAT NEW FINDS FOR YOUR WORKSHOP GREAT NEW FINDS FOR YOUR WORKSHOP

rotates the aperture-sensing ring to the smallest-aperture position. The actual coupling between the aperture-sensing ring and the galvanometer is visible toward the top of the mirror cage.

Locate the cam follower that traces against the cam surface of the aperture-sensing ring, Fig. 26. Turning the aperture-sensing ring in a clockwise direction — toward the larger apertures — pushes down the cam follower. And that rotates the galvanometer clockwise, as seen from the top. But it takes a little more disassembly to see exactly how the cam follower rotates the galvanometer.

To see the rest of the coupling, remove the trim plate (held by four screws, Fig. 26) and lift out the aperture-sensing ring. Then, take out the two screws holding the cam-follower cover plate. Move down the cover plate, as shown in Fig. 28, to expose the coupling parts.

A gear segment on the end of the cam follower engages the cord-control disc. The black cord that attaches to the cord-control disc runs underneath the cam follower to a control pulley. And the white cord routing around the control pulley is one we mentioned earlier — it's the same cord that attaches to the speed-sensing ring.

The drawing, Fig. 29, traces the complete route of the speed-sensing-ring cord. Beginning at the front of the camera, the cord hooks to the speed-sensing ring. The cord then follows within a track in the outer circumference of the speed-sensing ring and passes over the top of a guide pulley.

Another guide pulley routes the cord to the control pulley. The cord wraps once around the control pulley and then proceeds to another guide pulley on its way through a cutout in the front plate.

At the other side of the front plate, the meandering cord finally reaches its final destination. Here, it hooks to the spring-driven galvanometer-control disc at the bottom of the exposure-meter assembly.

So it's the speed-sensing-ring cord that rotates the galvanometer — both for shutter-speed changes and for aperture changes. Changing the shutter speed turns the speed-sensing ring; and the cord connects the speed-sensing ring directly to the galvanometer. Changing the diaphragm setting rotates the

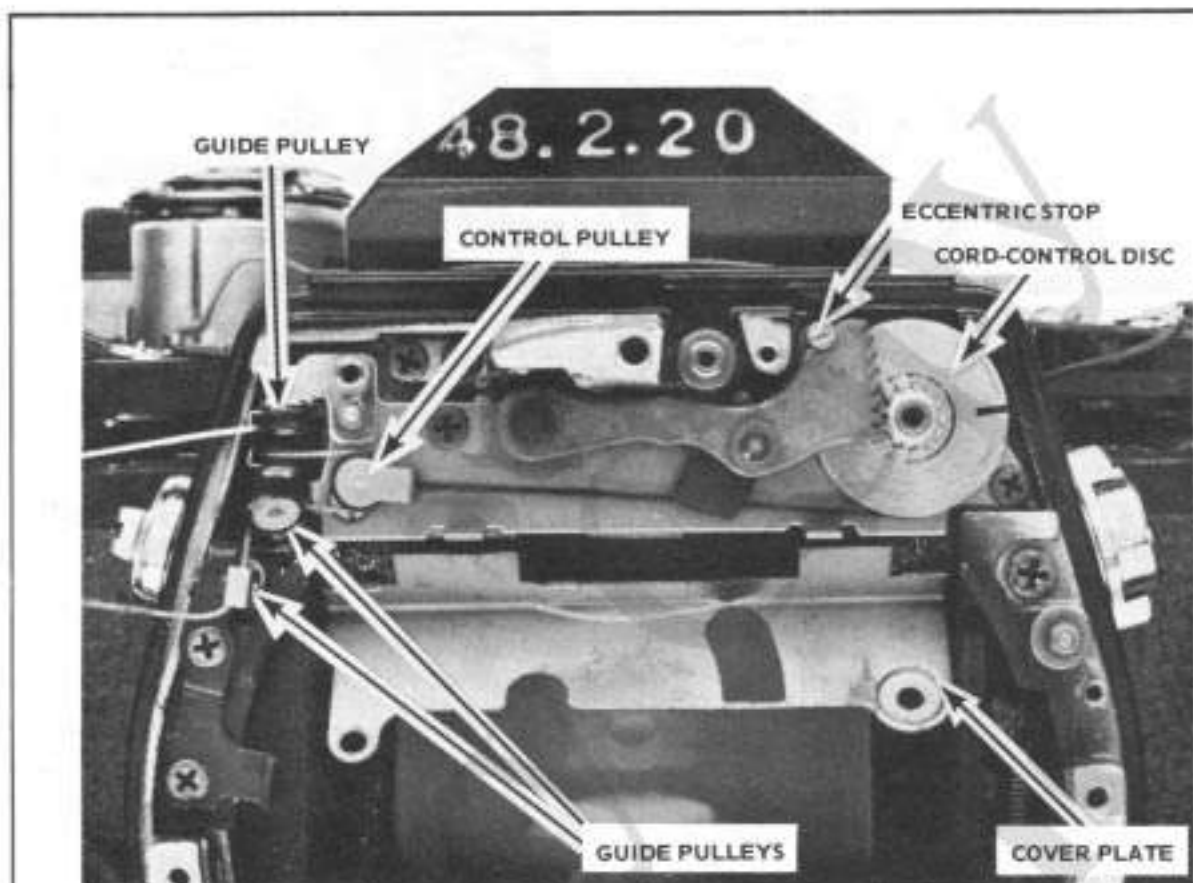

FIGURE 28

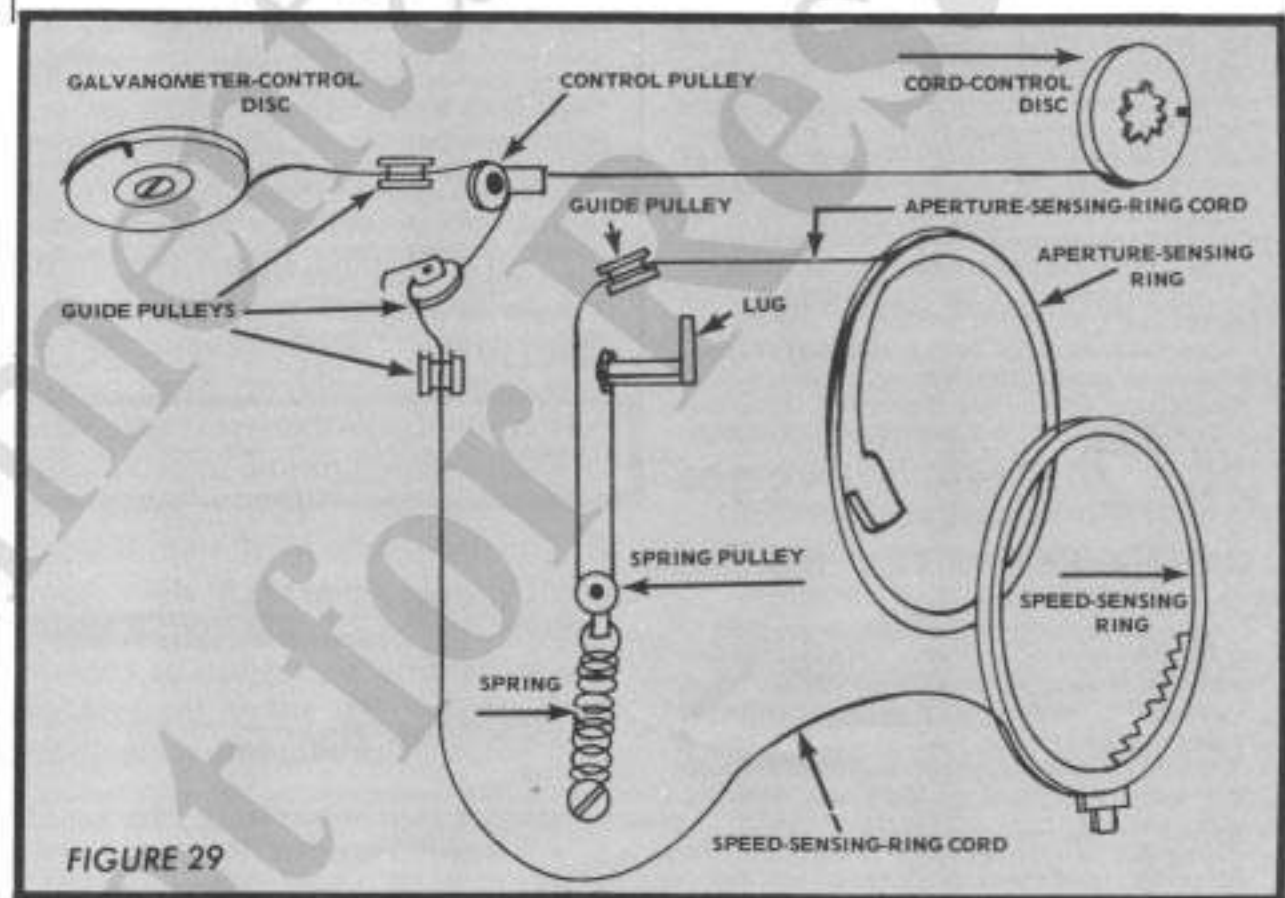

FIGURE 29

aperture-sensing ring to turn the cord-control disc; and the cord-control disc draws the speed-sensing-ring cord in one direction or allows the cord to pull in the other direction.

Notice in Fig. 28 that the cord-control disc has turned as far as it can go in a clockwise direction; here, the coupling slot in the cord-control disc is nearly horizontal. The part that limits the clockwise rotation of the cord-control disc is the cam follower — at its uppermost position, the cam follower comes against an eccentric stop. You can use the eccentric stop to time the cord-control disc as shown in Fig. 28.

(continued in next issue)

## FOR SALE

Camera repair service, established since 1955. Beautiful going business, with all types of rentals and camera shop. Has 4 darkrooms and 2 studios. New five year lease on building. \$30,000. Resort city.

Bob's Camera Repair,  
2312 E. Platte, Colo. Springs, CO 80909.

## WANTED

Authors with a good knowledge of camera repair. We'll help you rewrite (if needed) articles on repair techniques and experiences. Write: Editor, Camera Craftsman, 2000 W. Union Ave., Englewood, CO 80110.

Special thanks to Ponder & Best, who generously provided the Olympus OM-1 for our report.

# OLYMPUS

Part II (conclusion). The first part of this article appeared in the May/June Camera Craftsman.

## Electrical System In The OM-1 Exposure Meter

The tiny wires at the top of the camera tie together a rather unique exposure-meter system. With the space limitations, the routing of the wires becomes critical. So Olympus uses a fundamental approach to holding the wires in place — cement. How fundamental can you get?

You can see the exposure-meter battery switch to the left of the pentaprism in Fig. 30. The exposure-meter switch lever, remaining with the top cover, engages the switch-closing button pointed out in the illustration. To turn on the exposure meter, simply hold in the switch-closing button.

The black wire connected to one terminal of the battery switch goes to a terminal at the wind-lever side of the camera, Fig. 31. Each of the two red wires connected to the other terminal of the battery switch comes from a CdS photocell.

There's a second black wire attached to the terminal in Fig. 31 — this is the negative battery wire from the battery compartment. So one terminal of the battery switch connects to negative battery. The positive side of the battery is grounded through the camera body.

Fig. 32 shows how the circuit looks schematically. The terminal pointed out in Fig. 31 is more than a meeting place for the two black wires — it's also part of the warning switch. Looking at the schematic, notice that the warning switch S2 completely bypasses the battery switch and the CdS cells.

The black-wire terminal is actually a brush contact comprising one blade of the warning switch S2. A second brush contact, toward the back of the camera, connects to the galvanometer electrically through the yellow wire and the one visible resistor R4. Both brush contacts ride against an insulator band attached to the galvanometer housing.

In Fig. 33, we've removed the galvanometer to get a better look at the two warning-switch contacts. Normally, the insulator band on the galvanometer housing keeps the two contacts separated. So the brush contacts play no part in the meter's operation. But if the galvanometer rotates to an extreme position, both contacts mate with a common conductor strip at the end of the insulator band. Now, in effect, the two brush contacts are touching one another. And that closes switch S2 in the schematic.

Closing S2 hooks the galvanometer across the battery; only resistor R4 limits the current flow through the galvanometer. Notice that S2 turns on the exposure meter whether or not the battery switch S1 is closed. As a result, the galvanometer needle shoots up, toward the front of the camera.

The sudden needle deflection tells the photographer that he's reached the low-light metering limits — there's no way he can center the needle. Or, it can tell the user that he's forgotten to turn on the exposure meter. In trying to center the needle with the camera controls, he's reached the position of the galvanometer that closes S2.

To see when the warning switch S2 closed in our evaluation camera, we used the settings of ASA 1600 and "bulb." S2 then closed as we turned the diaphragm-setting ring from f/11 to f/8. All you have to do in checking the switch is hook your ohmmeter leads to the two brush contacts. At f/11, you should read an open between the two contacts — at f/8, a short.

There's a slight adjustment available on the warning-switch operation. After loosening the two screws holding the yellow-wire brush contact, you can shift the contact's

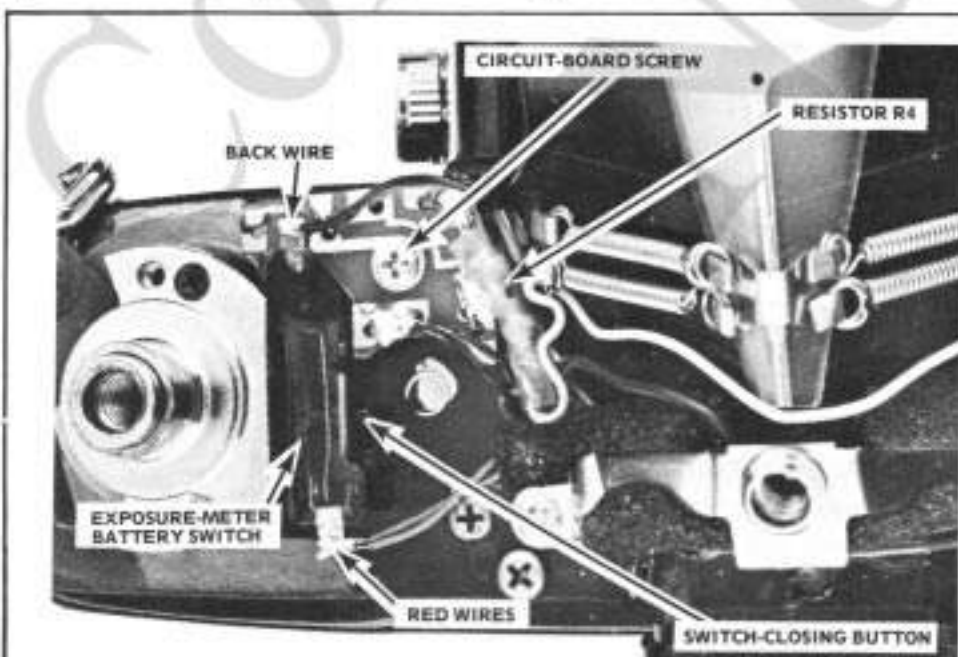

Figure 30

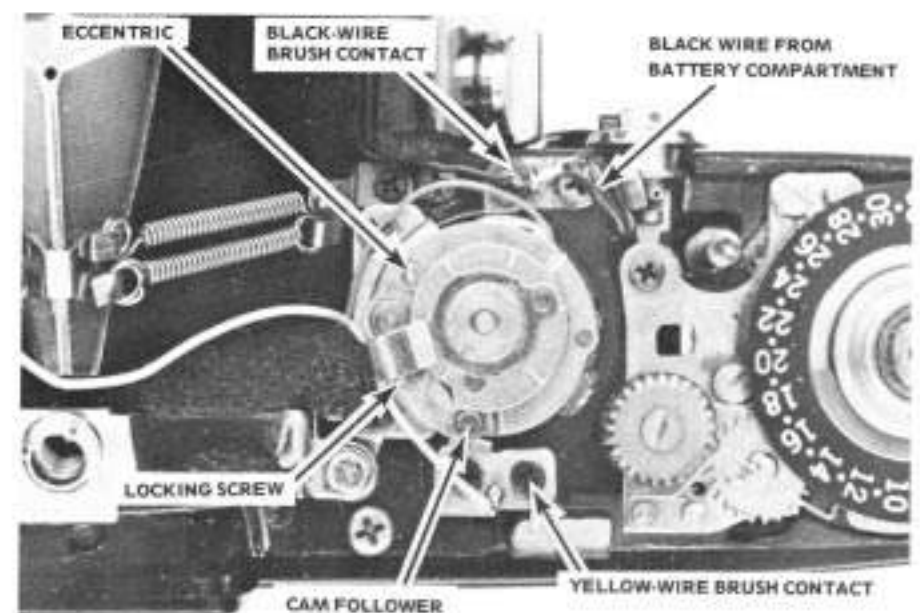

Figure 31

# OM-1

by Lawrence C. Lyells

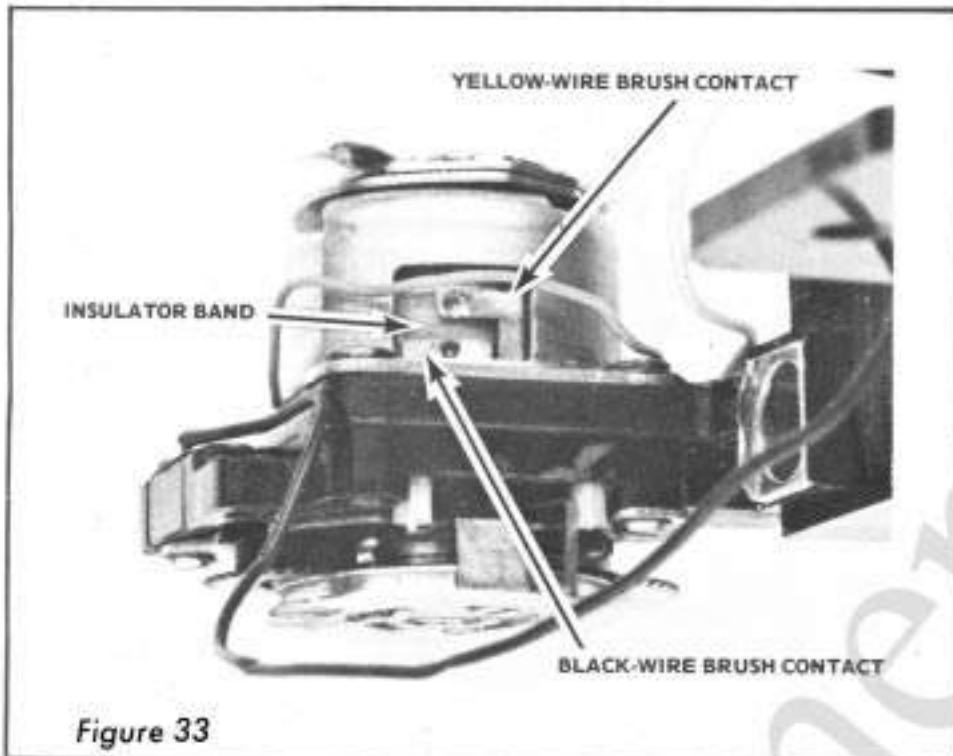

Figure 33

position. A setscrew accessible from the back of the camera, Fig. 34, positions the plastic block to which the brush contact mounts. Turning in the setscrew pushes the brush contact toward the insulator band of the galvanometer; as a result, the warning switch closes at a larger f/stop. Turning out the setscrew allows you to move the brush contact toward the back of the camera. And the warning switch closes at a smaller f/stop.

## Exposure-Meter Adjustments

One drawback to the exposure-meter system (from a technician's standpoint) is that there're no variable resistors for adjustment purposes. There's only one way to make electrical adjustments — change the values of the fixed resistors. Resistors R1, R2, and R3 in the schematic are the resistors used for adjusting the exposure meter. You can see the three resistors by removing the circuit-board screw, Fig. 30, and turning over the circuit board (careful: there's a spacer under the circuit board).

Fig. 35 points out the three fixed resistors as labeled in the schematic.

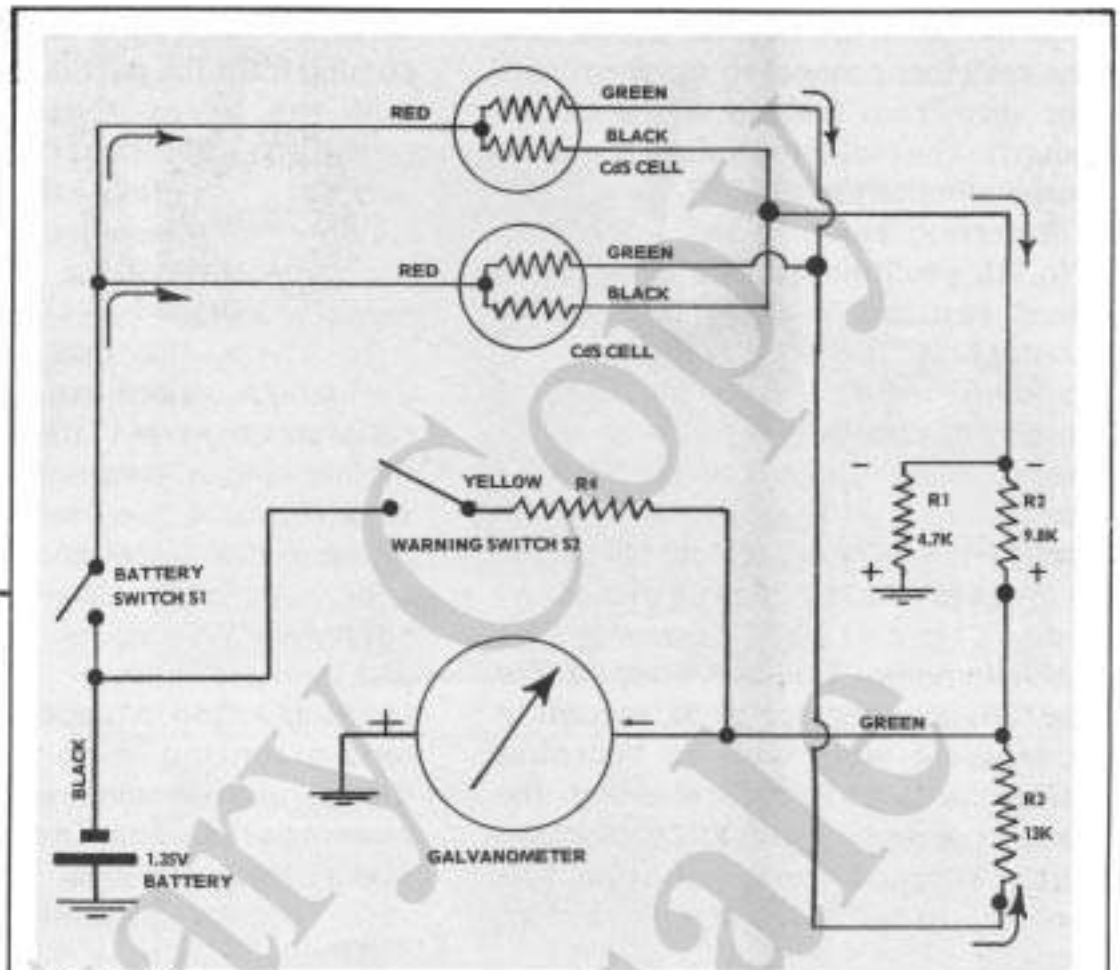

Figure 32

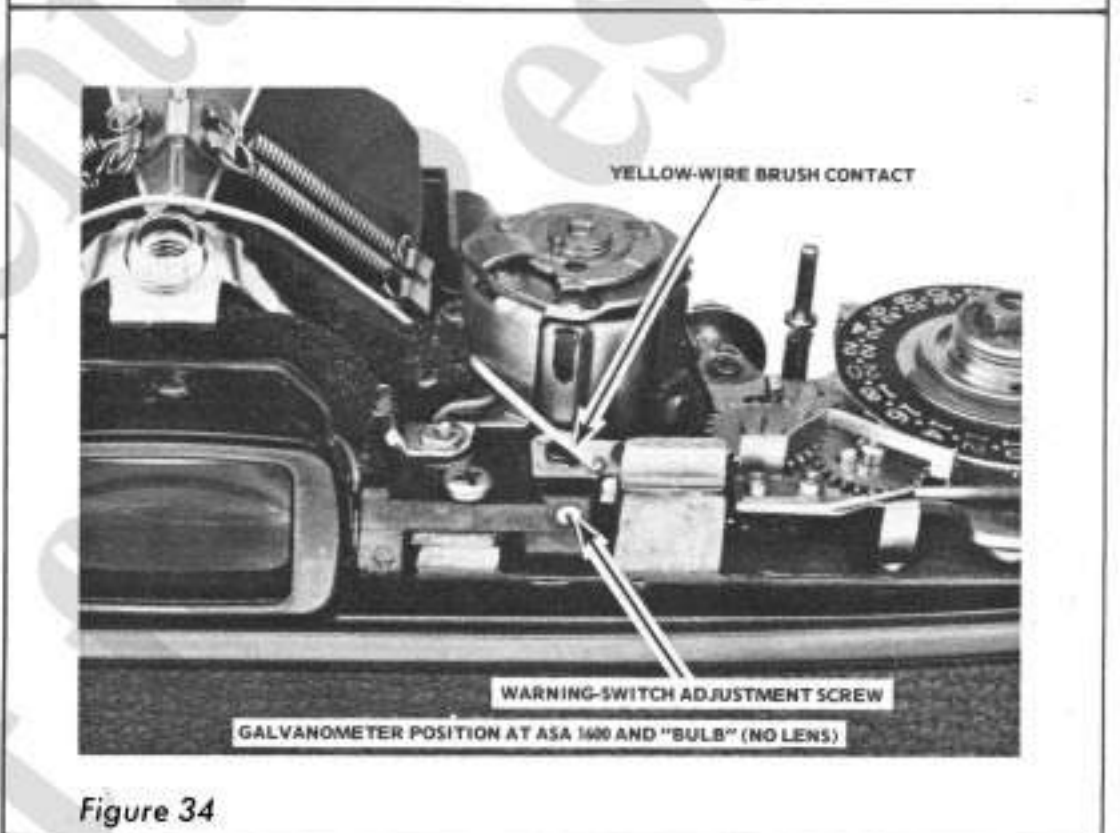

Figure 34

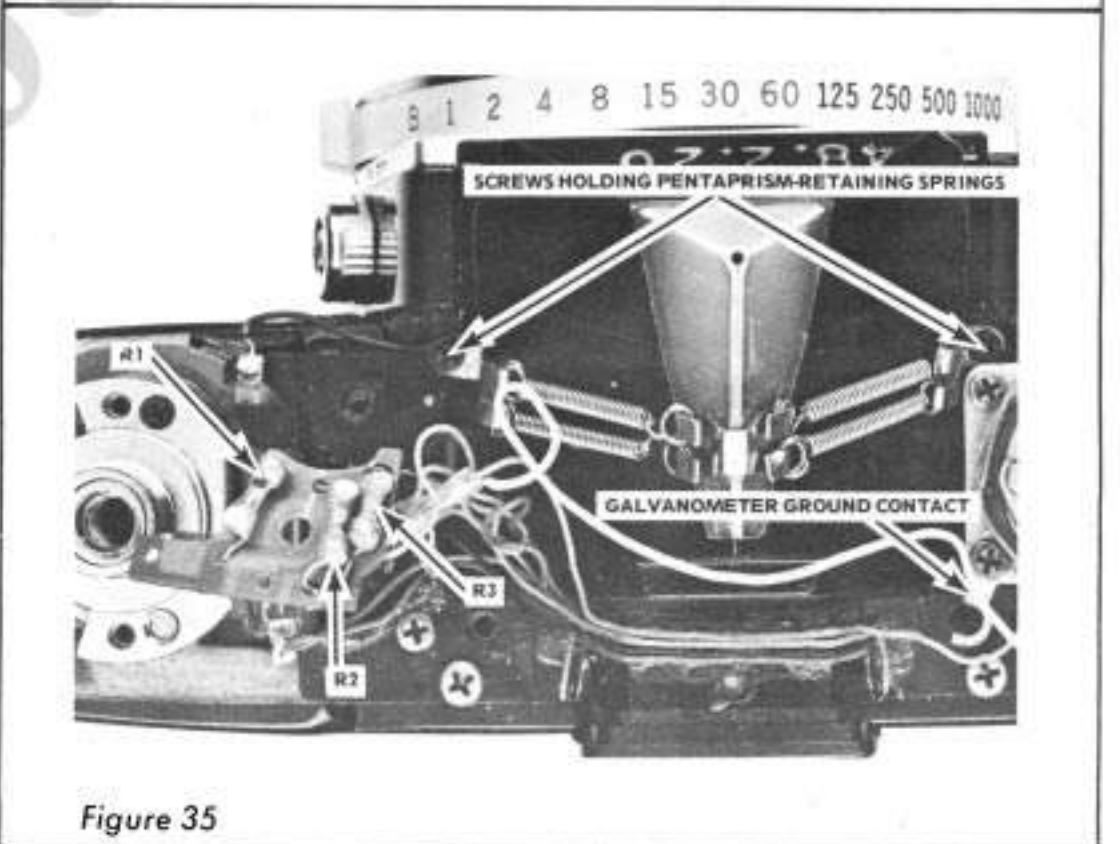

Figure 35

And the pictorial, Fig. 36, shows how the resistors connect to the terminals (as seen from the top of the circuit board). The indicated values are from our evaluation camera.

Referring again to the schematic, Fig. 32, you'll notice that each of the fixed resistors provides a linearity control. If you're adjusting the exposure meter over a full range of response, change the value of R2 to correct the high-light levels. Use R3 for the low-light levels. And adjust R1 for the middle range of light levels.

There's also a mechanical adjustment on top of the galvanometer. The cam follower for the film-speed cam, Fig. 31, mounts to a separate plate with an eccentric adjustment. By first loosening the locking screw, you can rotate the eccentric — that changes the rotational position of the galvanometer housing.

Such a mechanical adjustment may be used to adjust the total response (rather than the linearity). However, in the OM-1, the mechanical adjustment also affects the zero position of the needle (the position of the needle when there's no power applied to the circuit) and the operation of the warning switch. In our evaluation camera, the needle centered at the settings of ASA 1600, f/8, and "bulb." So, on reassembly, we used this combination of settings to set the needle's zero position.

## Checking And Replacing The CdS Cells

Notice that there are three leads coming from each of the CdS cells. The three leads indicate that each CdS cell consists of two light-sensitive resistances in parallel, a practical design for improving linearity.

Replacing a CdS cell requires that you remove the pentaprism. First, unsolder the hot-shoe sync wire — the wire from the hot-shoe connector joins the wire coming from the FP-sync contacts at the top of the camera. Then, take out the hot-shoe-connector bracket by removing its two screws.

Lifting aside the circuit board as shown in Fig. 35 allows you to reach both of the screws holding the pentaprism-retaining springs. Take out the two screws shown in Fig. 35, the pentaprism-retaining springs, and the pentaprism with its cover.

You can now see the windows over the two photocells, Fig. 37. To remove a photocell, unsolder the the green

wire, the black wire, and the red wire coming from the particular cell. Then, pull the wires loose — they're cemented in position. Once the wires are free, remove the cemented window over the photocell and pull out the cell toward the front of the camera.

To check the CdS cells in our evaluation camera, we compared the resistances across the leads while maintaining a constant light source. As a standard, we used the National Camera Comparalumen set at the f/5.6 light level (low-light window, unfiltered). Then, at the stage of disassembly shown in Fig. 34 — focusing screen in place — we held the lens-mounting ring against the Comparalumen window and checked the resistance across each combination of leads. Here are the results for one photocell:

between red and green leads — 1000 ohms  
between red and black leads — 10K  
between green and black leads — 11K

## Getting To The OM-1 Shutter

First appearances indicate that the mirror cage, exposure meter, and front plate come out of the camera as a complete unit. That would be great. But unfortunately we found it necessary to remove the exposure-meter assembly first — it insisted on catching the sprocket-release control.

Not that removing the exposure-meter assembly is a problem — it comes out as a complete module, a module that includes the photocells and the circuit board. There are only two wires to unsolder: the black wire from the hot-shoe contact (to remove the pentaprism) and the black wire running from the battery compartment to the brush contact, Fig. 37.

Once you remove the pentaprism, set the shutter to 1/1000 second; that lets off all but the initial tension from the galvanometer spring. Then, take out the screws at the top of the exposure-meter assembly (the two long screws, one on either side of the eyepiece, also serve to hold the front-plate/mirror-cage assembly).

Lifting off the exposure-meter assembly allows the spring to turn the galvanometer housing to the 1/1000-second position. Fortunately, there's no danger of the housing's flipping around and damaging the needle — a stop limits the housing's rotation. But

replacing the assembly does require a fair measure of dexterity and patience.

The ticklish problem is in getting the cord routed properly. The cord cements to a slot in the galvanometer-control disc, Fig. 38. From there, the cord passes around the outer circumference of the galvanometer-control disc and under a lug on the front plate, Fig. 39, on its way to the front of the camera.

We found that the reassembly is a little easier with the speed-sensing ring removed — that provides some slack in the coupling cord. Again, make sure that the shutter is at 1/1000 second before removing the speed-sensing ring; then, you don't have to search for the timing hole in the speed-setting gear.

There is, however, a trick you may find helpful in timing the speed-sensing ring — that's to remove the front piece of the lower light shield, Fig. 40. Cement holds the two sections of the light shield together. And removing the front piece allows you to easily see the timing hole in the speed-setting gear, Fig. 41. Another advantage of removing the front piece is that the front-plate/mirror-cage assembly comes off a little easier — especially if you also remove the lower light shield. A disadvantage is that it's pretty easy to distort the front piece.

Now, wrap the coupling cord twice around the galvanometer-control disc. The coupling cord must pass between the galvanometer-control disc and the guide tab, Fig. 38. Use the loose speed-sensing ring to hold the cord taut, keeping the cord seated on the galvanometer-control disc. As you seat the exposure-meter assembly, feed the cord underneath the front-plate lug, Fig. 39. Then, replace the retaining screws and seat the speed-sensing ring at the 1/1000-second position.

Disassembly doesn't disturb the mechanical timing of the galvanometer housing — providing, that is, you don't disconnect the cord. But in the event you do have to change the galvanometer's position, there's an adjustment available at the bottom of the galvanometer-control disc, Fig. 42. The galvanometer-control disc is in two sections: the outer section that controls the cord and the center section. A pinion on the brass disc at the center engages the two gears visible in the illustration. By loosening three screws, Fig. 42, it's possible to

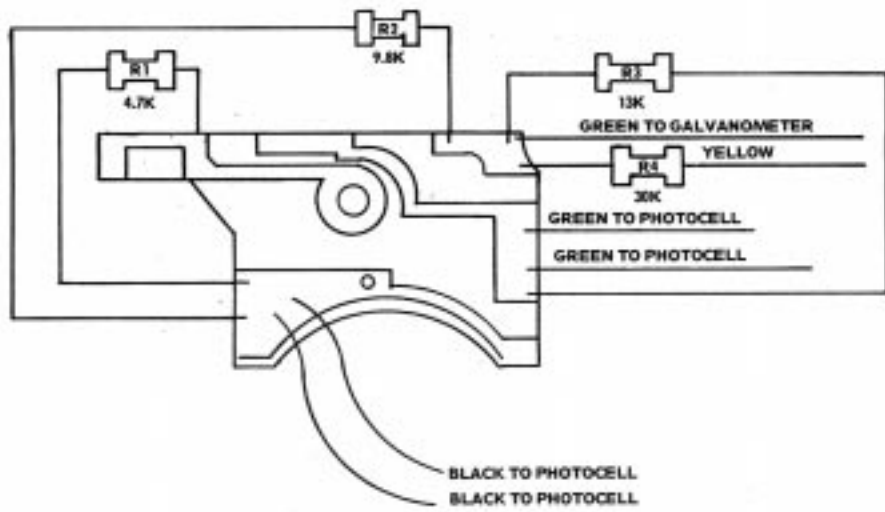

Figure 36

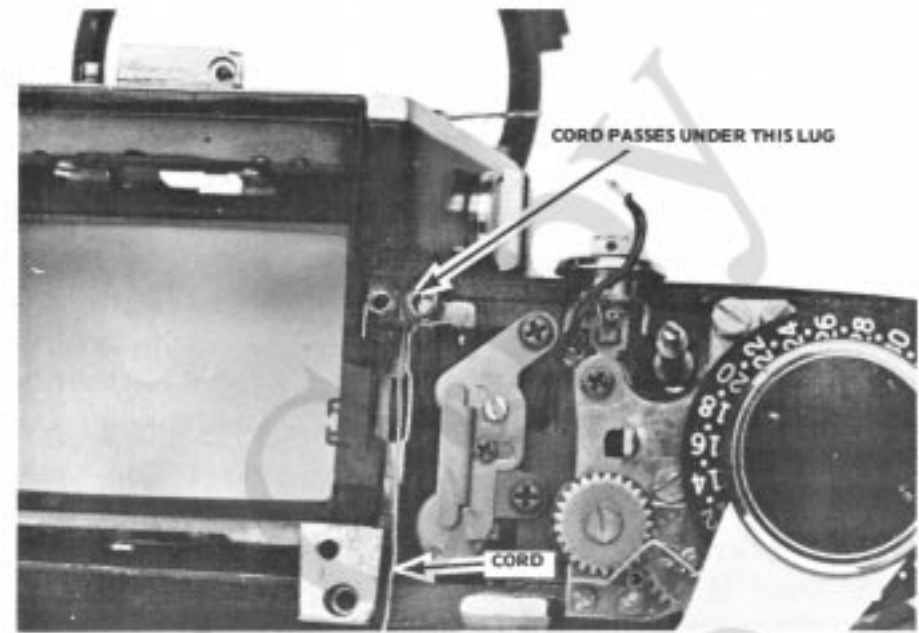

Figure 39

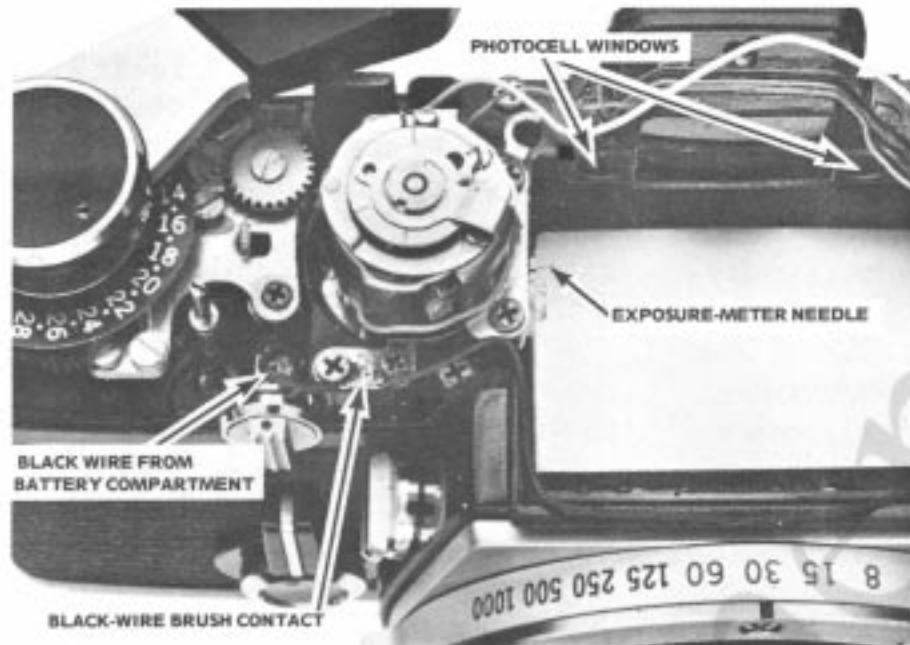

Figure 37

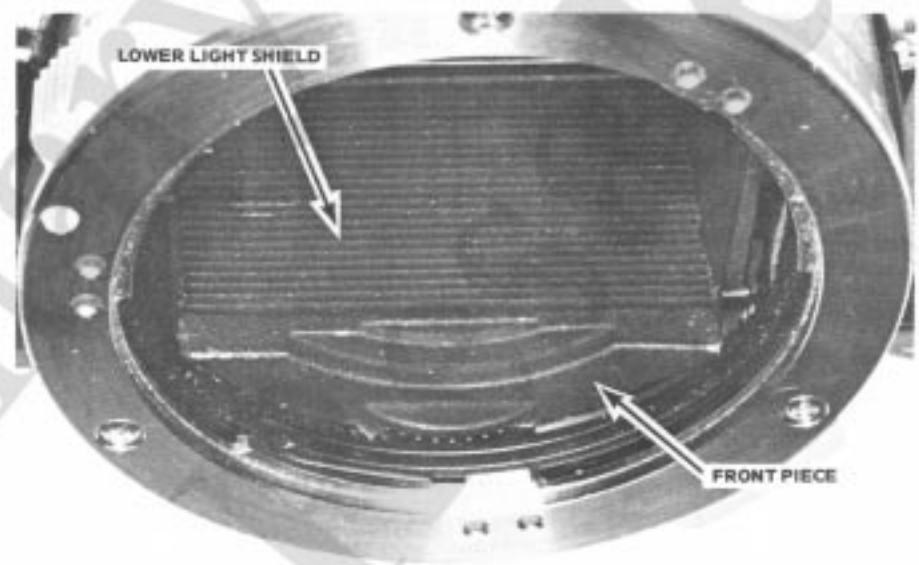

Figure 40

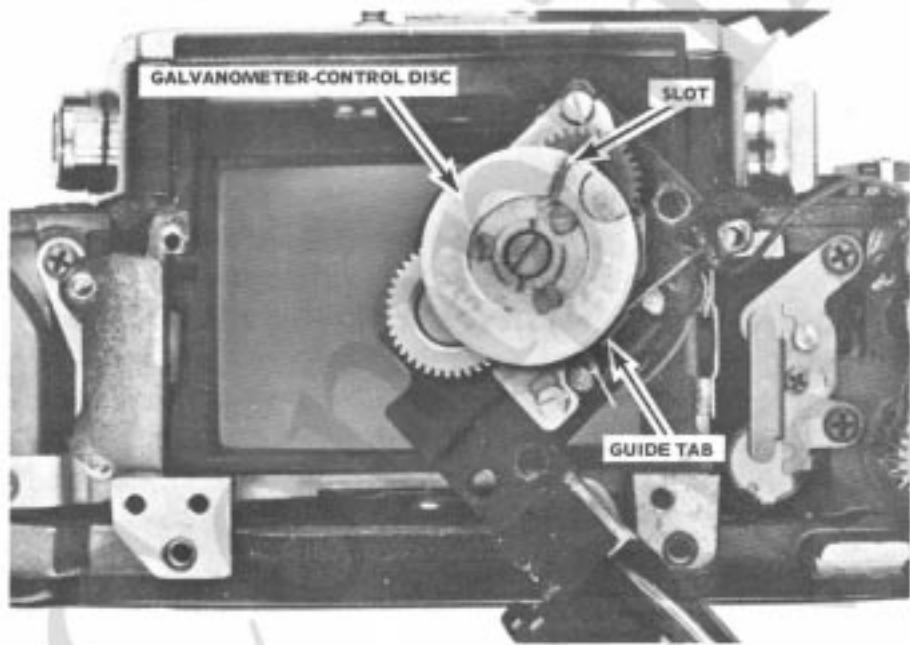

Figure 38

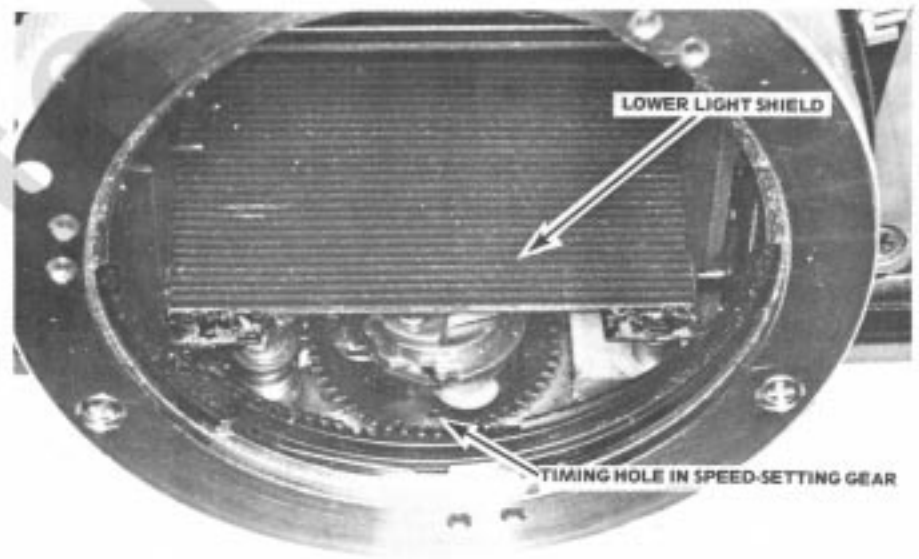

Figure 41

rotate the outer portion of the disc without turning the center section.

The adjustment shown in Fig. 42 may be considered a rough adjustment for the galvanometer's position; the fine adjustment is the eccentric on the film-speed cam follower. If you detach or replace the cord — and find that you can't get enough adjustment out of the eccentric — you can use the rough adjustment to correct the needle's zero position.

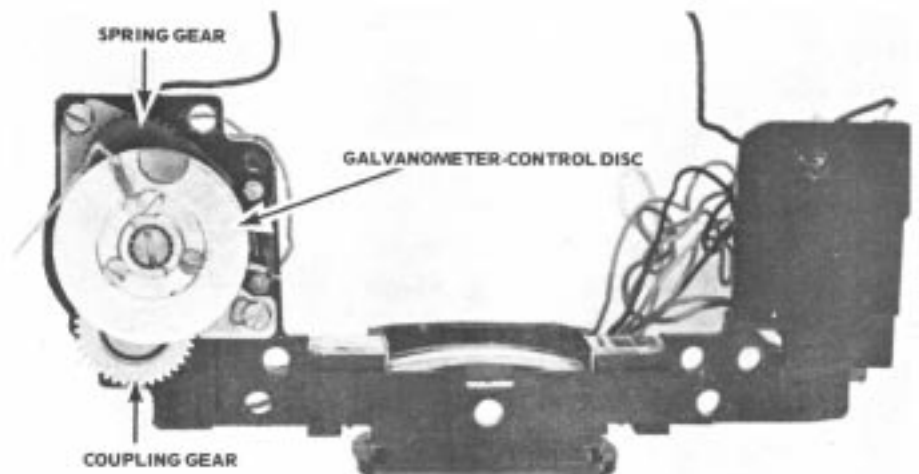

Figure 42

While at the bottom of the exposure-meter assembly, note the two gears, Fig. 42. Both gears engage the pinion of the galvanometer-control disc. The black gear is spring-loaded — that's the spring that drives the galvanometer-control disc to the 1/1000-second position; the other gear couples the galvanometer-control disc to the galvanometer housing.

A pinion at the bottom of the coupling-gear shaft engages a gear segment connected to the galvanometer housing. So the galvanometer-control disc turns the coupling gear. And the coupling gear positions the galvanometer.

Setting different film speeds moves the coupling gear in an arc, again positioning the galvanometer. The coupling gear mounts to an arm running to the top of the galvanometer housing. Here, the arm connects to the film-speed-cam-follower assembly.

So much for the exposure meter. Continuing with the front-plate disassembly, unsolder the sync wires at the bottom of the camera — the three red wires which connect to one another and the black wire which connects to the FP-sync contact.

Four screws under the front leatherette hold the front-plate/mirror-cage assembly. To remove the left-side leatherette, you'll have to take off the delayed-action cocking lever. The delayed-action cocking lever, like the wind lever, has a decorative plate with two spanner holes. You can either remove the cemented decorator plate or turn the decorator plate until its holes align with the holes in the retaining screw.

Cock the delayed-action escapement (so it won't run down) and return the delayed-action cocking lever to its rest position. The retaining screw has a **left-hand thread**. (As a matter of fact, several of the screws in the OM-1 have left-hand threads.) Remove the retaining screw by turning it in a clockwise direction. Lift out the spring washer, the delayed-action cocking lever, and the spacer sitting over the delayed-action cocking shaft.

You must also remove the decorator ring under the delayed-action cocking lever. Removing the decorator ring, held by two screws, allows you to peel off the left-side leatherette. Peel off both sections of leatherette to reveal the four front-plate screws.

There's one more trick involved in disassembly. Even with the exposure-

meter assembly and the four front-plate screws removed, the front-plate/mirror-cage assembly still doesn't want to come out. You'll find that the assembly is loose, yet some part is catching.

The argumentative part is the opening-curtain striker at the bottom of the camera, Fig. 43. With the mirror in the viewing position, the opening-curtain striker catches on the camera body. Yet the opening-curtain striker can clear the camera body with the mirror in the taking position. Remember, as the mirror moves up, the opening-curtain striker swings toward the back of the camera.

So one disassembly trick is to leave the mirror in the taking position. First, cock the shutter. Then, pull the front plate slightly away from the camera body — that's possible with the screws removed. The mirror latch on the mirror cage now moves away from the mirror-return lever.

Manually release the mirror by pushing the mirror-release lever, Fig. 43, toward the front of the camera. The mirror should flip up and remain in the taking position (providing, that is, the mirror latch is far enough away from the mirror-return lever). Although it still takes some manipulation, you can now separate the front-plate/mirror-cage assembly from the camera body.

There're other tricks you can use to keep the mirror in the taking position. For one, you can simply remove the opening-curtain release lever. Then,

since the mirror can't release the shutter, the shutter can't return the mirror. But removing the opening-curtain release lever does disturb an adjustment. The bearing for the opening-curtain release lever is eccentric; by first loosening the screw, you can turn the eccentric bearing. The adjustment determines how soon the opening curtain releases once the mirror starts its climb to the taking position.

### Replacing The Front-Plate/ Mirror-Cage Assembly

For reassembly, you'll again want the mirror in the taking position. If you want to operate the mirror-cage parts — just to see how everything works (or if everything works) — try pushing the mirror latch, Fig. 44, toward the front of the mirror cage; that returns the mirror to the viewing position.

Raise the mirror to the taking position by first tensioning the mirror-lifting spring — just push the mirror-tensioning lever toward the front of the mirror cage until it latches. Then, release the mirror by pushing forward the mirror-release lever, Fig. 44.

Before seating the front-plate/mirror-cage assembly, feed the red and black sync wires through the hole in the bottom of the camera. Now, seat the front-plate/mirror-cage

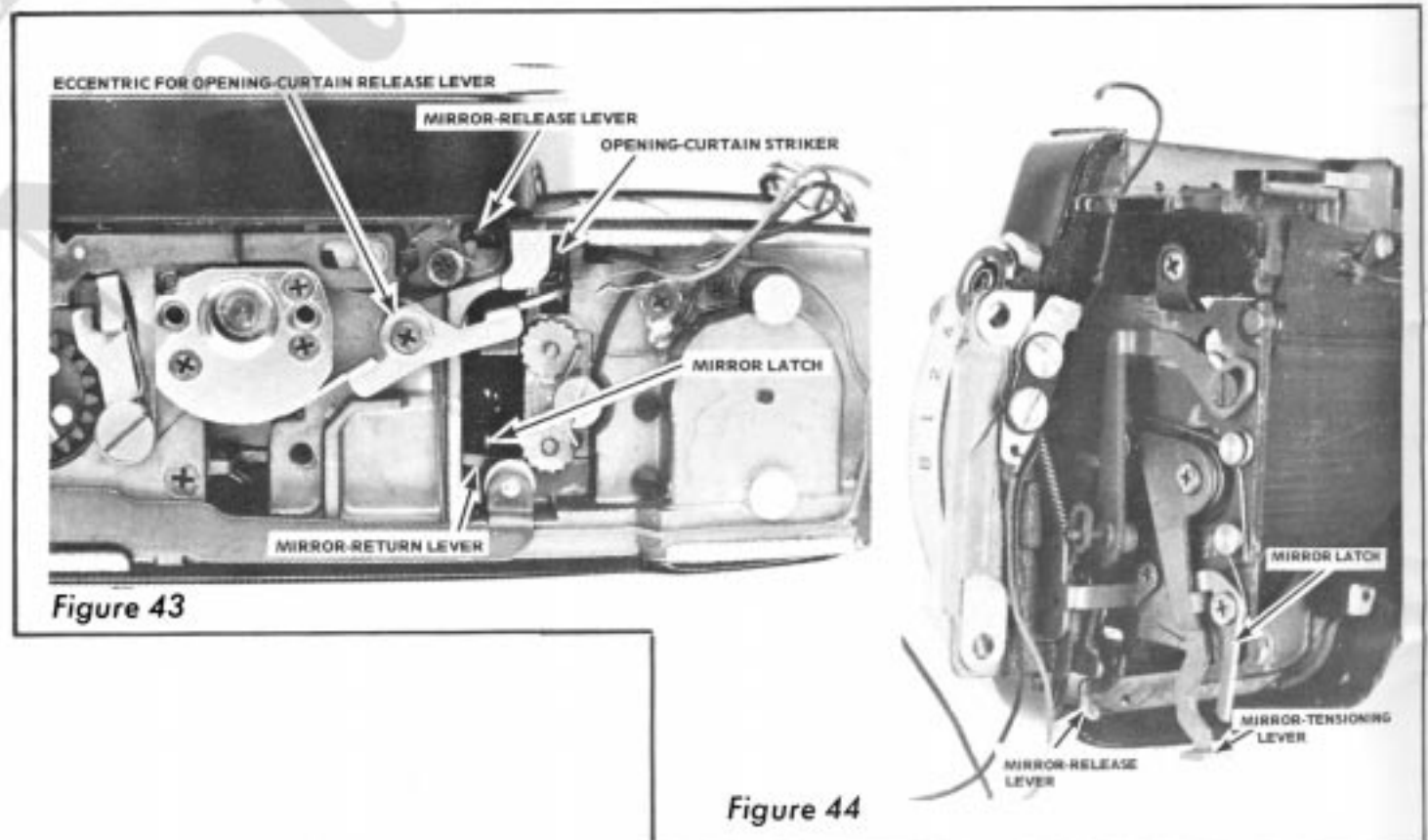

Figure 43

Figure 44

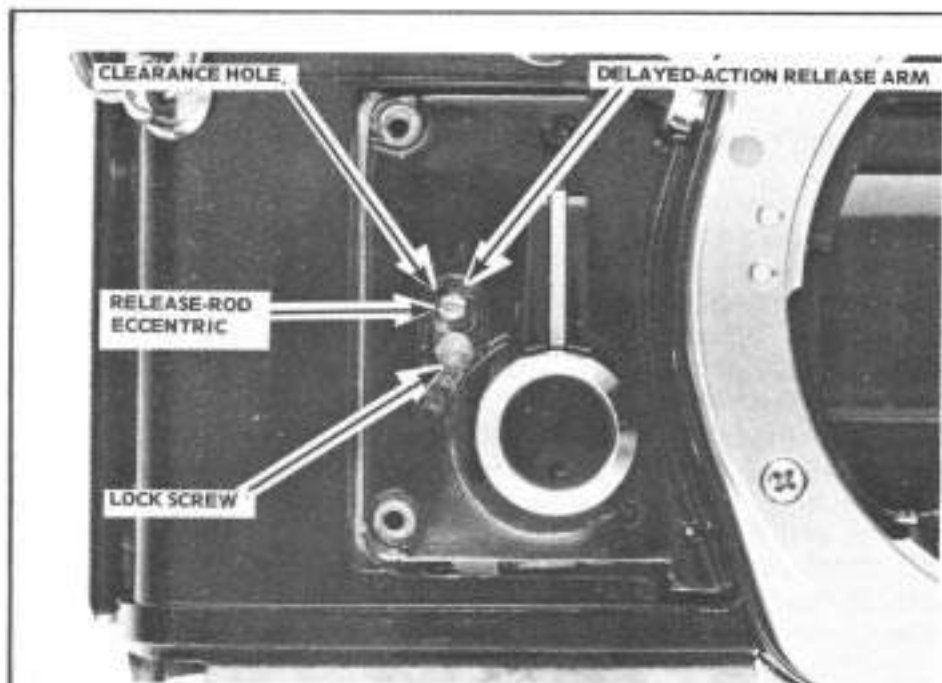

Figure 45

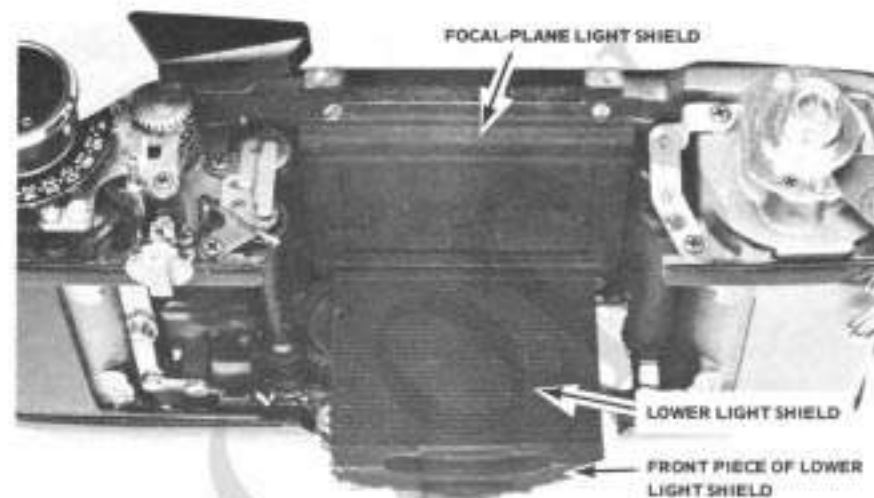

Figure 46

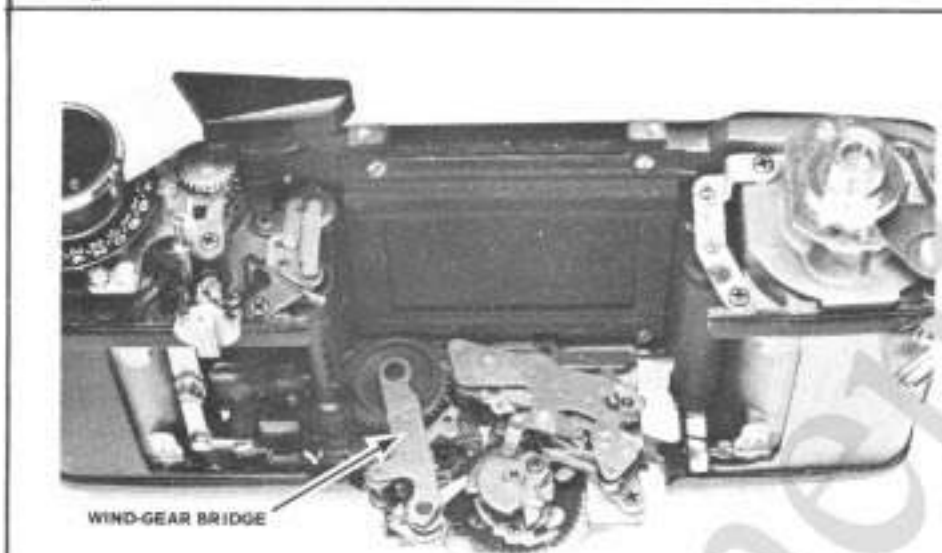

Figure 47

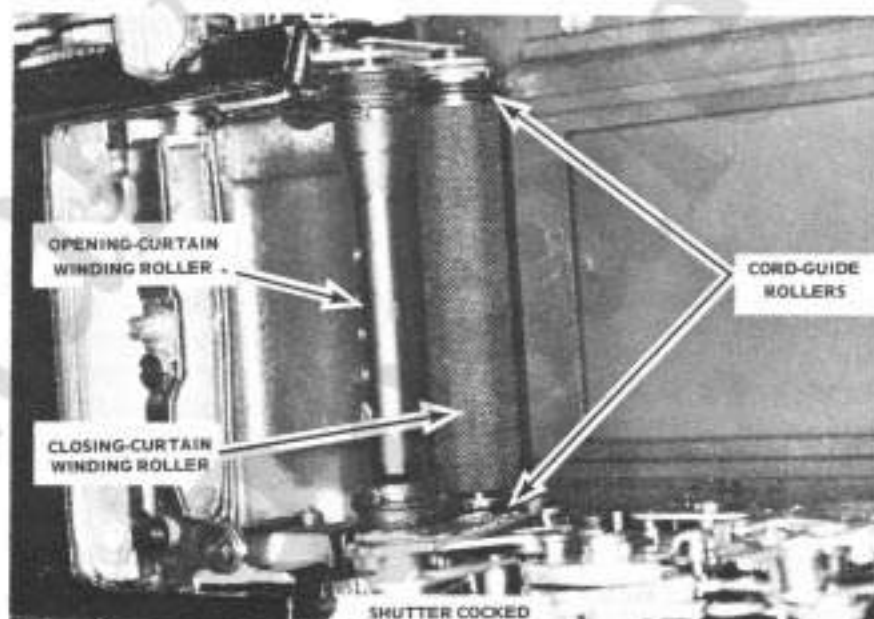

Figure 48

assembly in the camera body. There are a couple of important points to watch for during this portion of the reassembly. For one, make sure the opening-curtain striker is to the front of the opening-curtain release lever (between the opening-curtain release lever and the front of the camera). And assure that the mirror latch is to the front of the mirror-return lever, Fig. 43.

One more part needs a little help in getting into the proper position — the delayed-action release arm. Chances are the delayed-action release arm is now sitting beneath the eccentric stud on the release rod; it has to be to the top of the stud. Then, as the delayed-action escapement runs down, the delayed-action release arm pulls down the release rod.

From the front of the camera, slightly lift the delayed-action side of the front plate. Work through the clearance hole in the front plate to position the delayed-action release arm on the top edge of the eccentric stud, Fig. 45.

The clearance hole also allows you

to reach the eccentric for adjustment purposes. By loosening the lock screw, Fig. 45, you can turn the eccentric. The eccentric adjustment controls the overtravel of the release rod following the delayed-action cycle. That is, the delayed-action release arm pushes down the release rod far enough to trigger the mirror — the delayed-action release arm should then continue pushing down the release rod for a slight distance after the mirror releases.

### Shutter System In The OM-1

Removing the mirror cage spotlights the space-saving techniques in the OM-1. As you can see in Fig. 46, there're no curtain-control gears at the tops of the opening and closing-curtain winding rollers — there's just enough room for the rollers themselves. All of the curtain-control parts are underneath the light shield at the bottom of the camera.

Getting to the curtain-control parts at first appears to be a problem; there're no screws holding the light shield. Again the OM-1 uses cement, a

space-saving shortcut that's beginning to look like a trademark. The light shield cements to the wind-gear bridge, Fig. 47. Obviously, recementing the light shield requires some care; a little surplus cement could ooze onto the curtain-control parts. (As indicated earlier, you may prefer to remove the light shield before taking off the front-plate/mirror-cage assembly — that makes both the disassembly and the reassembly a little easier.)

Besides the uniqueness of the curtain-control parts — all neatly nestled at the bottom of the camera — there's another display of originality now apparent: the shutter curtains run on cords rather than on tapes. On the spring-loaded closing-curtain take-up roller, the cords attach to the outer ends of the roller. During the release cycle, each cord winds toward the center. On the opening-curtain winding roller, the cords wind toward the outer ends of the roller as you cock the shutter, Fig. 48.

(continued page 28)

# OLYMPUS OM-1

(continued from page 9)

## Shutter-Speed Controls And Adjustments In The OM-1

At first glance, the shutter-control mechanism may appear somewhat alien, Fig. 49. Yet the operation is typical of double-roller focal-plane shutters. Olympus has just packed the familiar parts in one area. And in the process, the OM-1 eliminates much of the coupling linkage you'd expect to see in a focal-plane shutter.

The closing-curtain latch (the part that holds back the closing curtain after the opening curtain releases) sits under the wind-gear bridge. It's right above the disengaging lever, the part that decides when the closing curtain should release. Fig. 49 points out both parts.

At the bottom of the camera, Fig. 50, you can see a tab extending from the closing-curtain latch. Notice that

the end of the latch-control lever engages the tab — that holds the closing-curtain latch out of action, away from the closing-curtain wind gear. But depressing the release rod moves the release slide from left to right in Fig. 50; and a downward-projecting pin on the release slide pushes the latch-control lever away from the closing-curtain latch. Now free to move, the spring-loaded closing-curtain latch swings toward the curtain-wind gears.

The latching end of the closing-curtain latch moves into engagement with a lug on the closing-curtain wind gear, Fig. 51. When the mirror rises to the taking position, it releases the opening-curtain wind gear — the closing-curtain wind gear would like to follow. But the closing-curtain latch restrains the closing-curtain wind gear, providing a slit between the two curtains.

On "bulb," the closing-curtain latch remains engaged until you let up the release rod. The release slide then

moves from right to left, permitting the latch-control lever to swing counterclockwise. The latch-control lever then pushes the closing-curtain latch out of engagement to free the closing-curtain wind gear.

On instantaneous speeds, the disengaging lever frees the closing curtain. That downward-projecting pin on the closing-curtain latch comes against the side of the disengaging lever, Fig. 51. So when the disengaging lever moves in a clockwise direction, it strikes the pin and pushes the closing-curtain latch away from the closing-curtain wind gear.

The part that strikes the disengaging lever is the opening-curtain wind gear. A release cam formed on the top of the opening-curtain wind gear drives the disengaging lever against the closing curtain latch. The slit width, then, depends on when the release cam strikes the disengaging lever. To change the slit width, the camera just

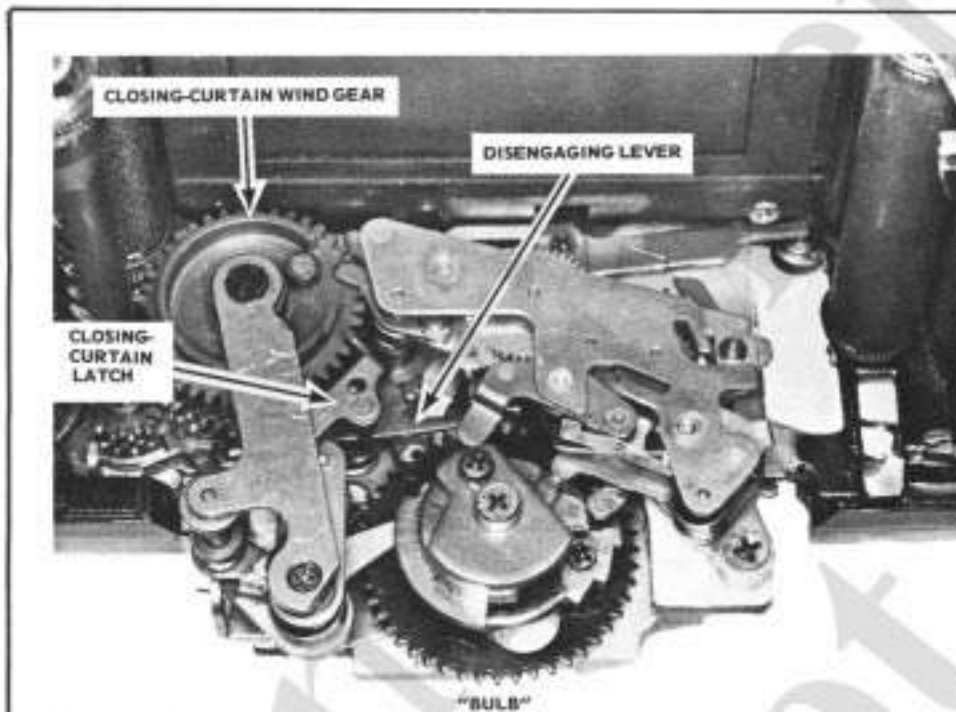

Figure 49

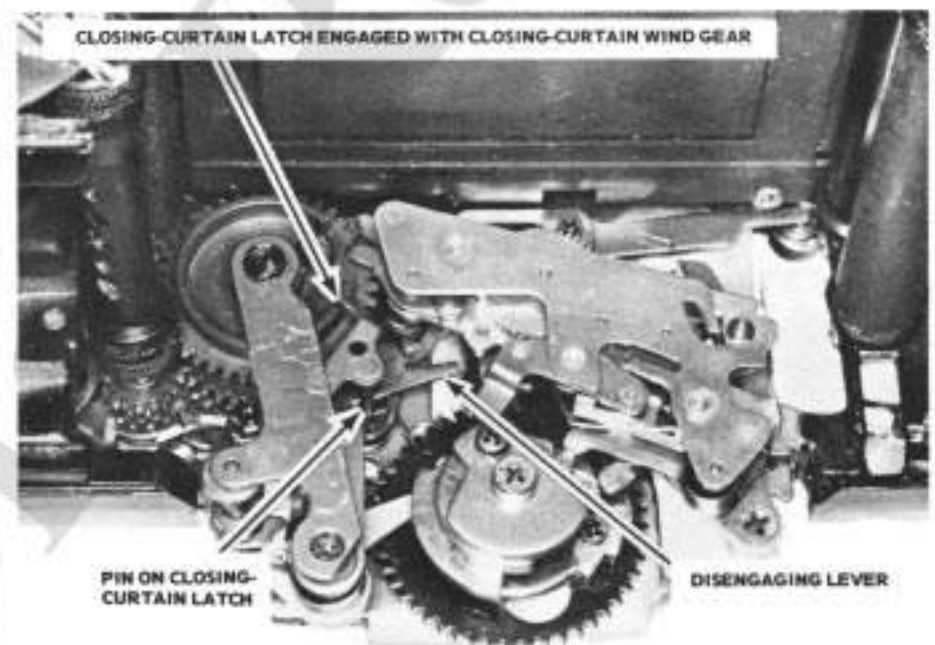

Figure 51

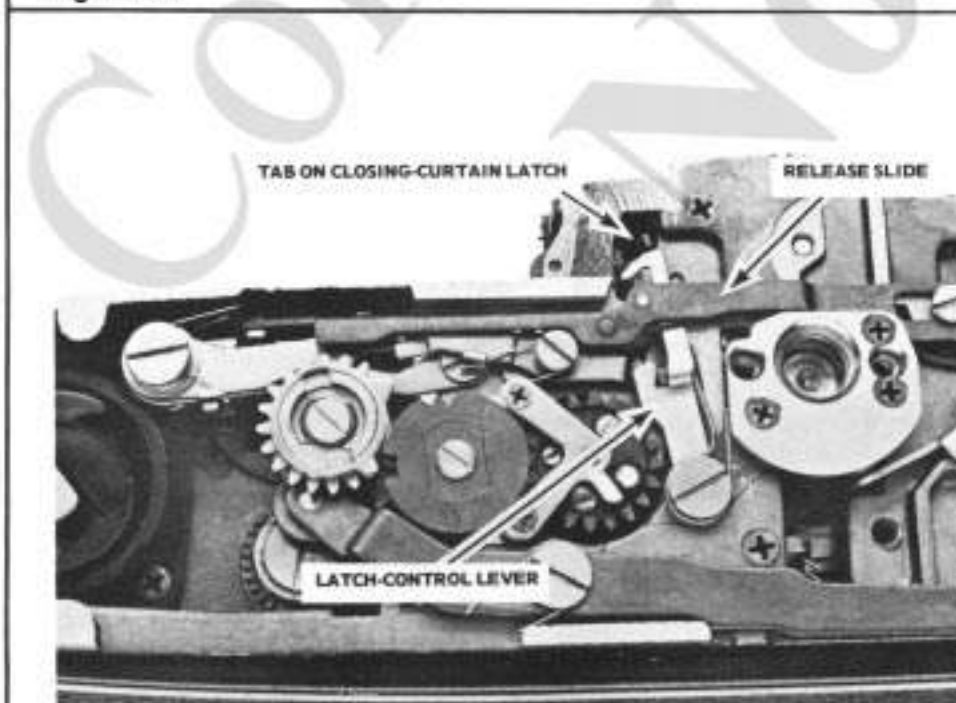

Figure 50

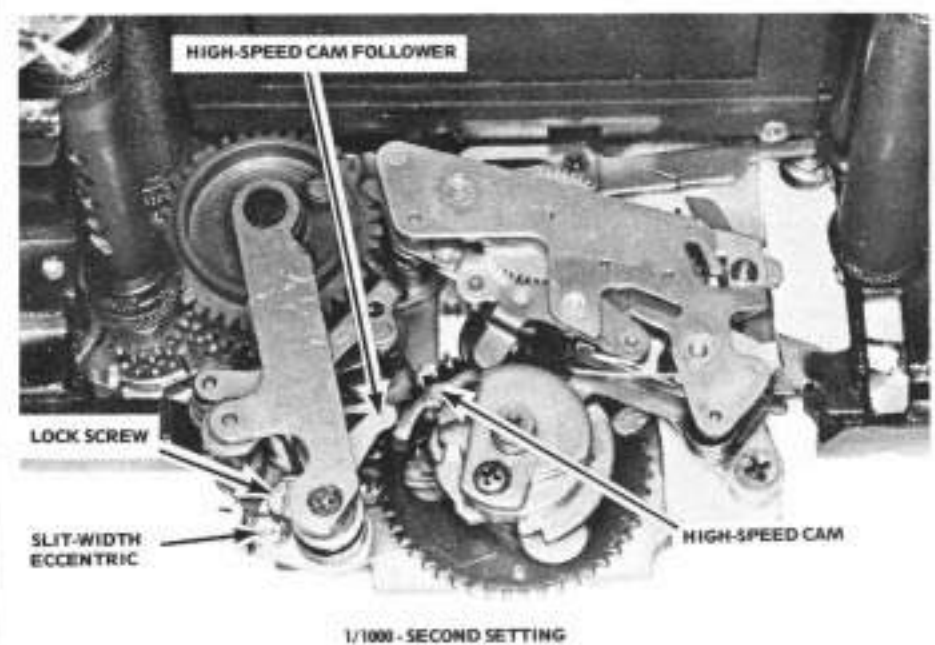

Figure 52

repositions the disengaging lever with respect to the release cam.

Controlling the position of the disengaging lever is the job of the high-speed cam — that's the bottom cam in the speed-control cam stack. The high-speed cam follower tracing against the high-speed cam, Fig. 52, mounts to one end of a spring-loaded lever; the other end of this lever carries the disengaging lever.

At the fastest speed (1/1000 second), Fig. 52, the high-speed cam moves the disengaging lever as far as it can toward the curtain-wind gears. And at "bulb," Fig. 49, the disengaging lever moves as far as it can toward the speeds escapement; here, the release cam never strikes the disengaging lever.

The adjustment for the slit-width speeds — 1/1000 second through 1/60 second — is the eccentric on the high-speed cam follower. By first loosening the lock screw, Fig. 52, you can turn the eccentric. And turning the eccentric changes the position of the

high-speed cam follower with respect to the spring-loaded lever that carries the disengaging lever.

You can check and adjust the shutter speeds at this stage in disassembly. Just hold the release rod depressed (so the closing-curtain latch can engage) and push the opening-curtain release lever against the opening-curtain latch. Check 1/1000 second by first turning the speed-setting gear until its timing hole faces the front of the camera, Fig. 52 — notice that the last step in the high-speed cam is now against the high-speed cam follower. Set the other slit-width speeds by turning the speed-setting gear until the high-speed cam follower is against the appropriate step.

The remaining three cams in the speed-control cam stack control the speeds escapement. Next up from the high-speed cam is the slow-speed cam — this cam governs the amount of retard engagement. The retard-control lever, held out of action at 1/60

second, drops into play at 1/30 second, Fig. 53; that allows the retard lever to move into the path of another lug on the closing-curtain wind gear. At 1/15 second, the retard lever moves into deeper engagement with the retard-drive lug.

Both speeds-escapement pallets remain disengaged from their respective star wheels at 1/15 second. Then, at 1/8 second, Fig. 54, the uppermost cam on the speed-control cam stack allows the high-speed pallet to engage its star wheel.

The high-speed pallet remains engaged at 1/4 second; it then disengages at 1/2 second and 1 second, Fig. 55. Now, the slow-speed pallet moves into engagement with the slow-speed star wheel. Only the two slowest speeds use the slow-speed pallet.

There aren't too many adjustment points for the slow speeds. You can, however, make a slight sliding adjustment on the speeds escapement after loosening its two screws. It seems logical to adjust the speeds-escapement position at 1/30 second, the fastest retard speed. Also, you can adjust the depth of engagement for each pallet — reforming the pallet-stop bars allows more or less pallet engagement. Set the engagement for the high-speed pallet at 1/8 second, the fastest speed at which the high-speed pallet is engaged. And set the engagement for the slow-speed pallet at 1/2 second.

### Curtain Action In The OM-1

Removing the focal-plane light shield provides a better look at the shutter curtains. Take out the two screws at the top of the focal-plane light shield; then, loosen the cross-

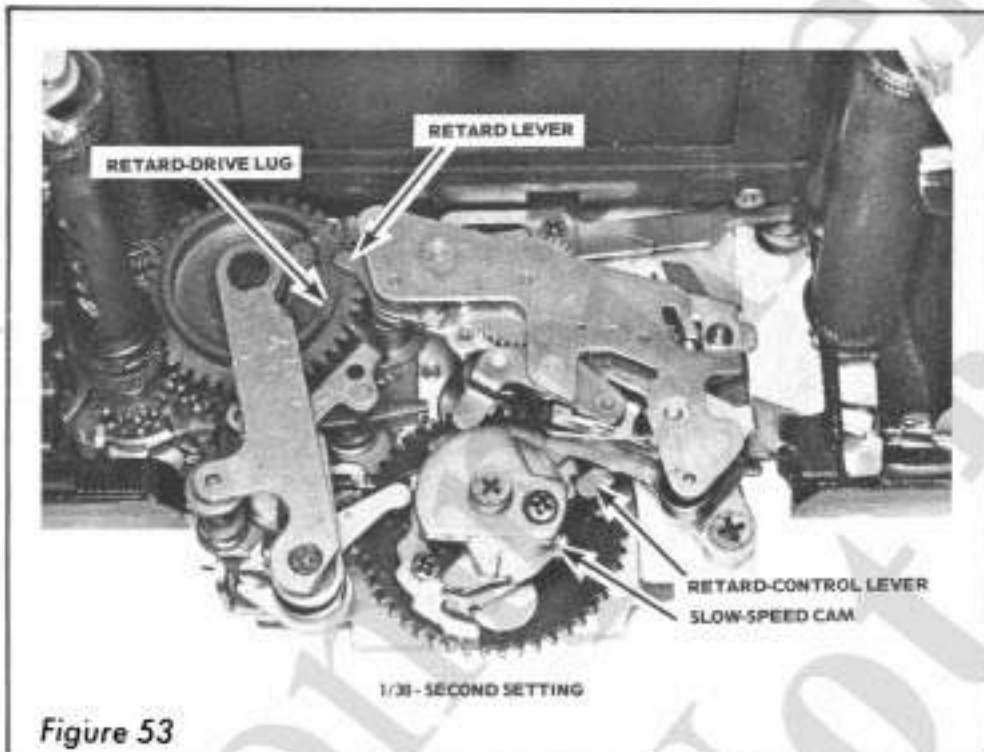

Figure 53

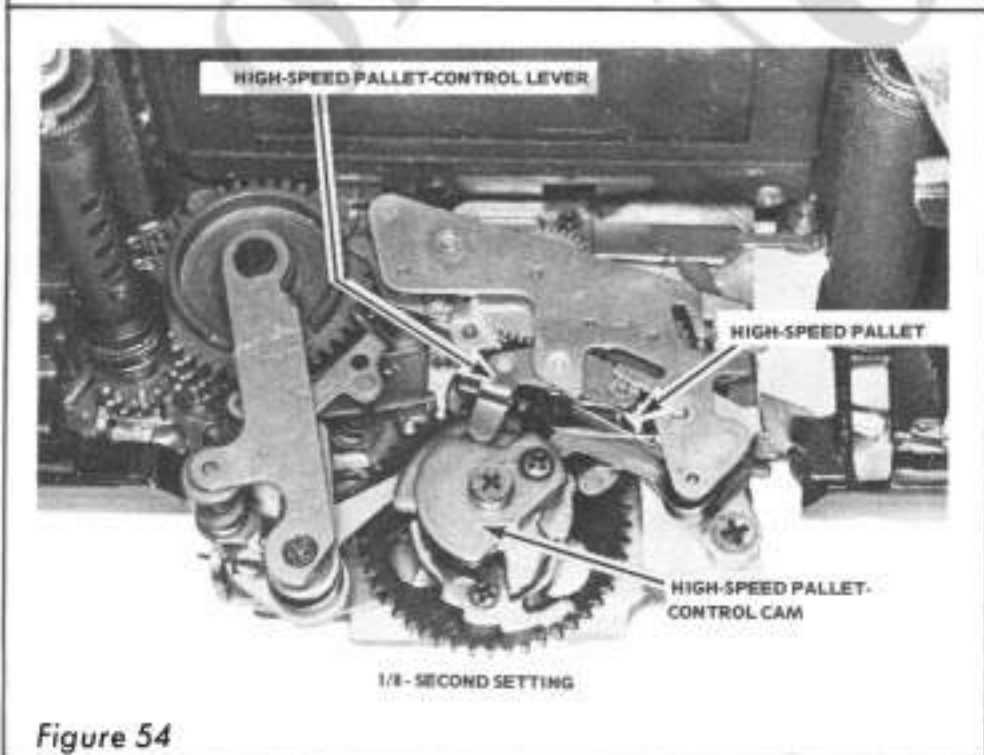

Figure 54

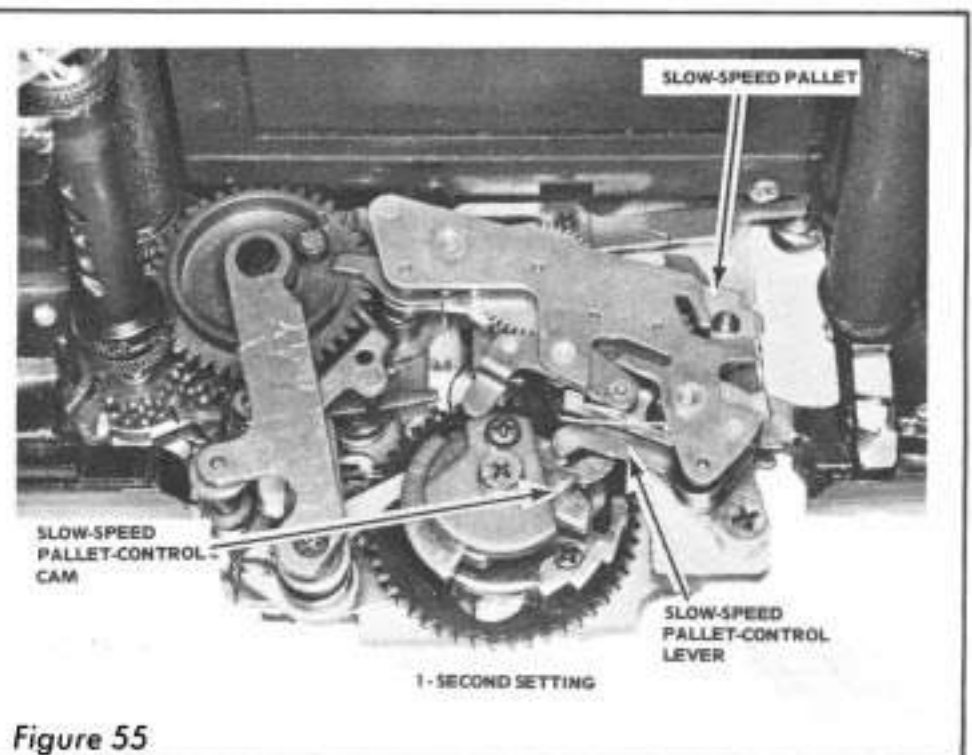

Figure 55

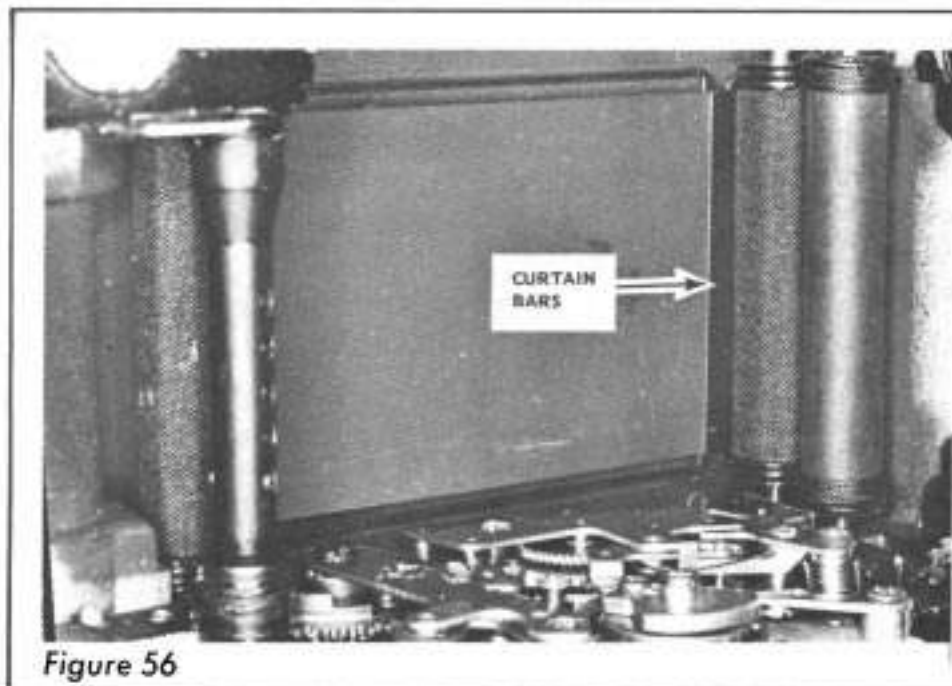

Figure 56

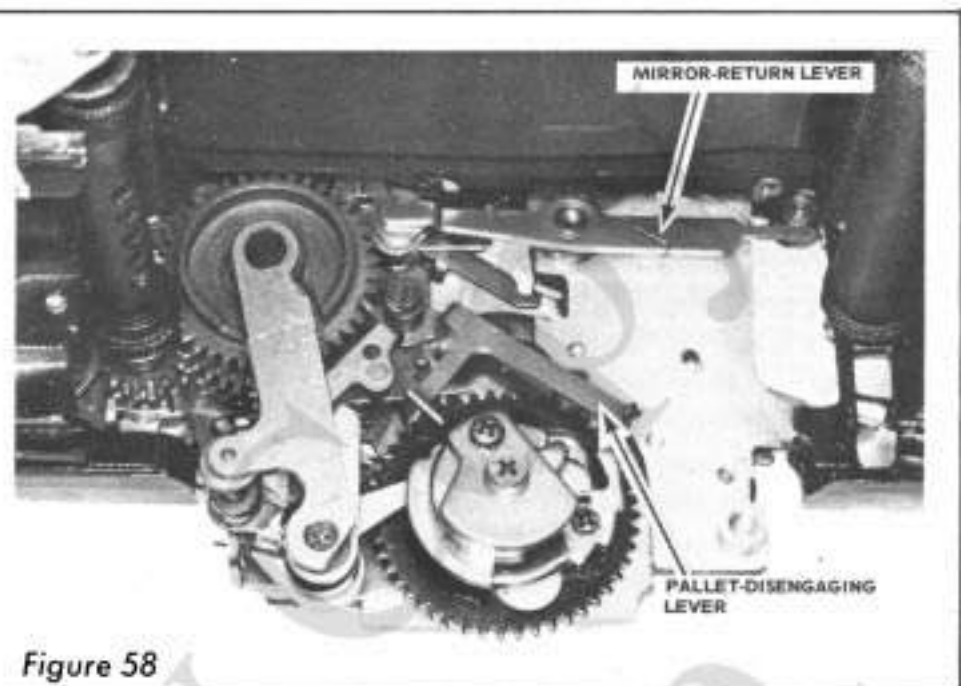

Figure 58

point screw toward the bottom. Slide the focal-plane light shield up and out of the camera body.

It's now possible to examine the rather unique action of the OM-1's curtains. In the shutter-released position, the two curtains overlap by the conventional one-bar width, Fig. 56. But as you cock the shutter, the opening-curtain wind gear rotates a slight distance before it picks up the closing-curtain wind gear. So there's quite an overlap — over two bars — as the curtains start traveling to the "ready" position.

Half-way across the focal-plane aperture, the curtains overlap by a two-bar width, Fig. 57. Then, the closing curtain catches up to the opening curtain. In the tensioned position, the curtains again overlap by a one-bar width.

With the shutter held open at "bulb," the closing curtain remains around 4mm behind the lead edge of the focal-plane aperture. Here, the OM-1 provides a convenient timing reference. Notice the two scribe lines near the top of the camera body, Fig.

57. As long as the closing-curtain latch engages the closing-curtain wind gear, the top of the closing-curtain bar should center between the two scribe lines — that's the reference for the timing between the closing-curtain wind gear and the closing-curtain winding roller.

### Removing And Replacing The Speeds Escapement

Remove the speeds escapement by taking out its two retaining screws. You can now see the pallet-disengaging lever and the mirror-return lever, Fig. 58. Both parts require some consideration when replacing the speeds escapement.

The mirror-return lever hooks to a stud on the closing-curtain brake lever, Fig. 59. In the shutter-cocked position, Fig. 60, the closing-curtain brake lever allows the spring-loaded mirror-return lever to swing toward the back of the camera. Then, as the closing curtain nears the end of the focal-plane aperture, the closing-curtain brake lever drives the mirror-return lever back to the position

shown in Fig. 58.

With the speeds escapement removed, the mirror-return lever may slip off the brake-lever stud. Or, the mirror-return lever may come off its pivot post. Make sure that the mirror-return lever hooks as shown in Fig. 59 before you replace the speeds escapement.

The other lever of concern, the pallet-disengaging lever, disengages both pallets in the shutter-cocked position. When you cock the shutter, the opening-curtain wind gear pushes the pallet-disengaging lever to the position shown in Fig. 60. The upturned tab at the extreme right-hand end of the pallet-disengaging lever then pushes the slow-speed pallet away from the slow-speed star wheel. Simultaneously, the tab near the speed-control cam stack engages a pin on the underside of the high-speed pallet-control lever.

It's easiest to replace the speeds escapement with the shutter cocked — the pallet-disengaging lever then stays in position. As you seat the speeds escapement, make sure the

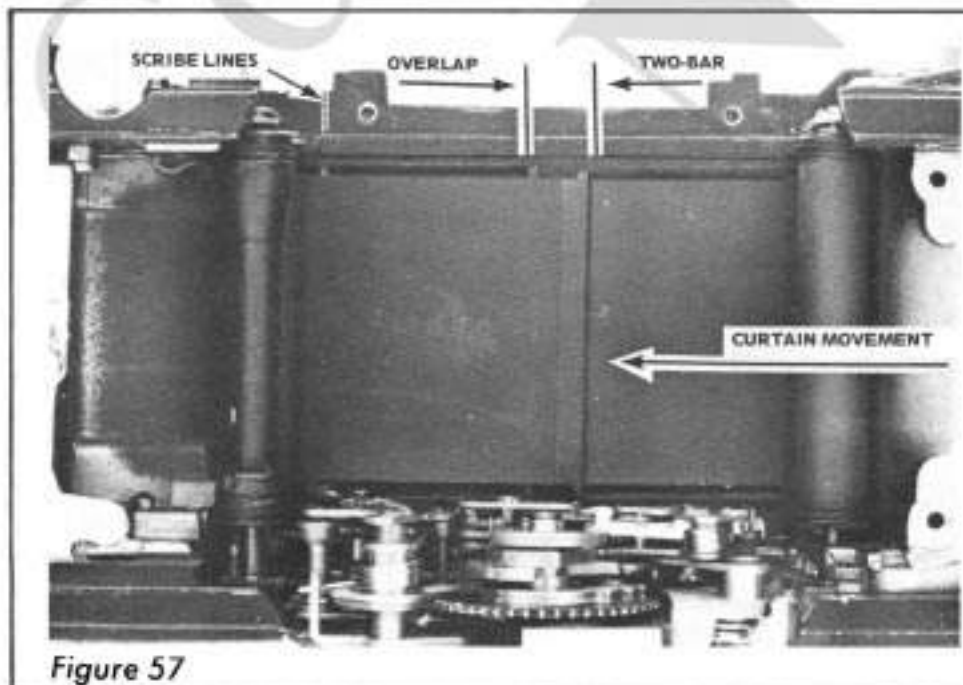

Figure 57

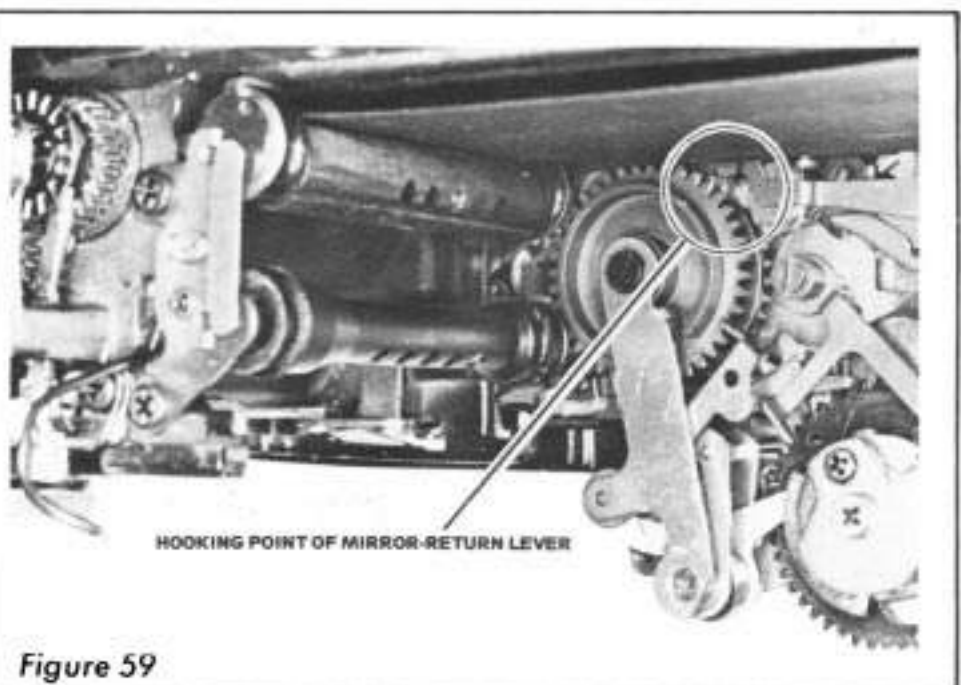

Figure 59

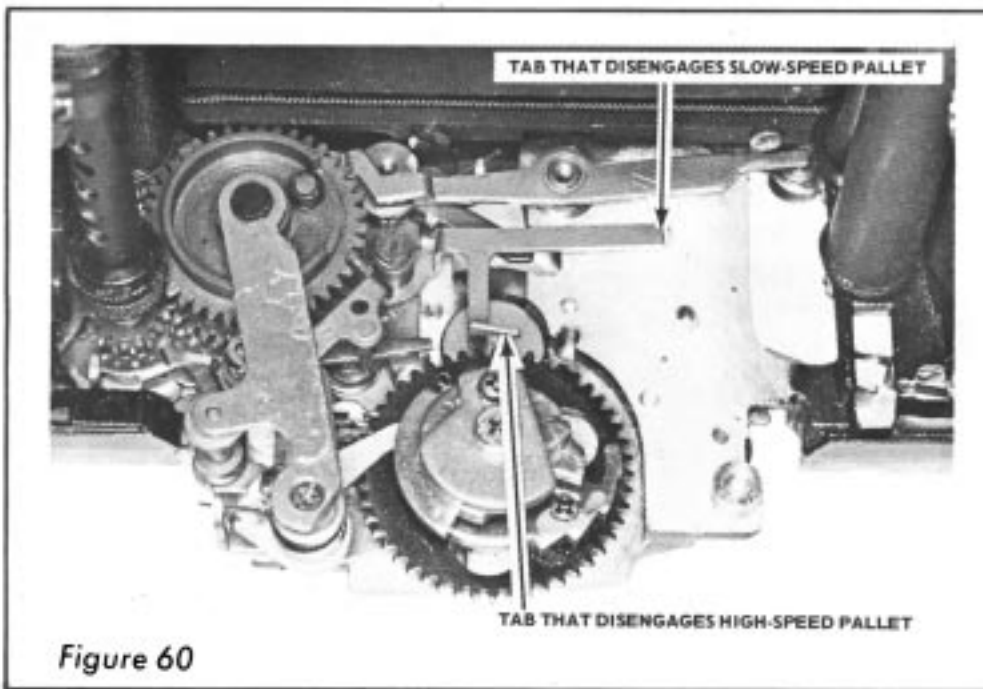

Figure 60

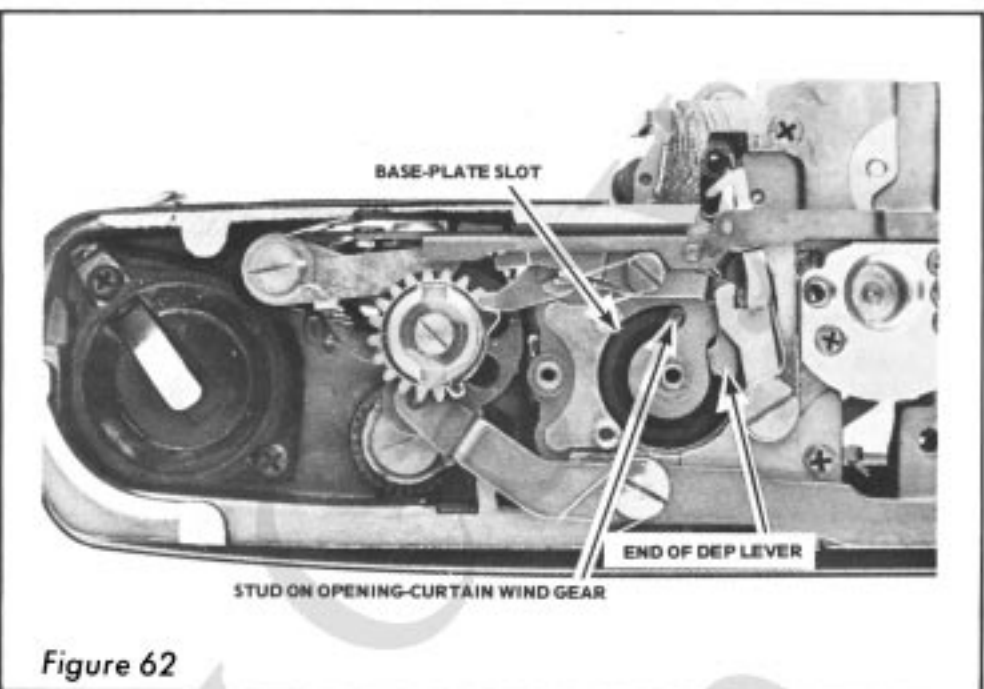

Figure 62

two pallet-control levers pass to the proper sides of the pallet-disengaging-lever tabs. The high-speed pallet-control lever goes to the outside of one tab; the slow-speed pallet-control lever goes to the inside of the other tab.

If you're going further in the disassembly, now's a good time to remove the mirror-return lever (the lever has a sneaky way of coming out on its own). Notice the position of the spring sitting underneath the mirror-return lever — one end of the spring hooks to the side of the mirror-return lever, the other end rests against the closing-curtain-brake post. Disconnect the hooked end of the spring from the side of the mirror-return lever. Then, lift out the mirror-return lever with its spring.

The speed-setting gear and the speed-control cam stack come out as one unit. Again, it helps to cock the shutter — the pallet-disengaging lever then moves out of the way. Remove the screw at the top of the speed-control cam stack, Fig. 60. Then, hold the high-speed cam follower against

its spring tension (away from the speed-setting gear) and lift out the cam-stack/setting-gear assembly.

### Disassembly And Timing Of The Curtain-Wind Gears

For a thorough cleaning and lubrication, you'll want to remove the curtain-wind gears at the bottom of the camera. You'll then be able to reach the lower pivots of the curtain-winding rollers.

Remove the second-wind-gear-and-cam assembly by taking out the screw shown in Fig. 61. As you lift up the gear, notice the spring — the looped end of the spring hooks around one of the support posts for the shutter-cocking-gear bridge. And the other end of the spring hooks within a slot in the second wind gear.

On reassembly, hook the spring to the second-wind-gear slot (there are two slots — the spring hooks to the side indicated in Fig. 61). Then, seat the second wind gear with the looped end of the spring hooked around the

support post. Lift the second wind gear high enough to clear the shutter-cocking gear; now, turn the second wind gear clockwise to the position shown in Fig. 61. Timing the second wind gear simultaneously applies the initial tension to the spring.

Three screws hold the shutter-cocking-gear bridge. But take note — the slotted screw passing through the center of the shutter-cocking gear has a left-hand thread. Remove the three screws and lift off the bridge. Then, lift out the shutter-cocking gear.

Earlier, we pointed out the stud on the opening-curtain wind gear, Fig. 62. As you'll recall, the shutter-cocking gear engages this stud to advance the curtains. But the stud has three additional functions. For one, as the opening-curtain wind gear reaches the cocked position, the stud comes against the end of the DEP lever indicated in Fig. 62. The DEP lever then swings in the direction shown by the curved arrow in Fig. 63 — that allows two levers to drop into engagement with the transport cam underneath the first wind gear.

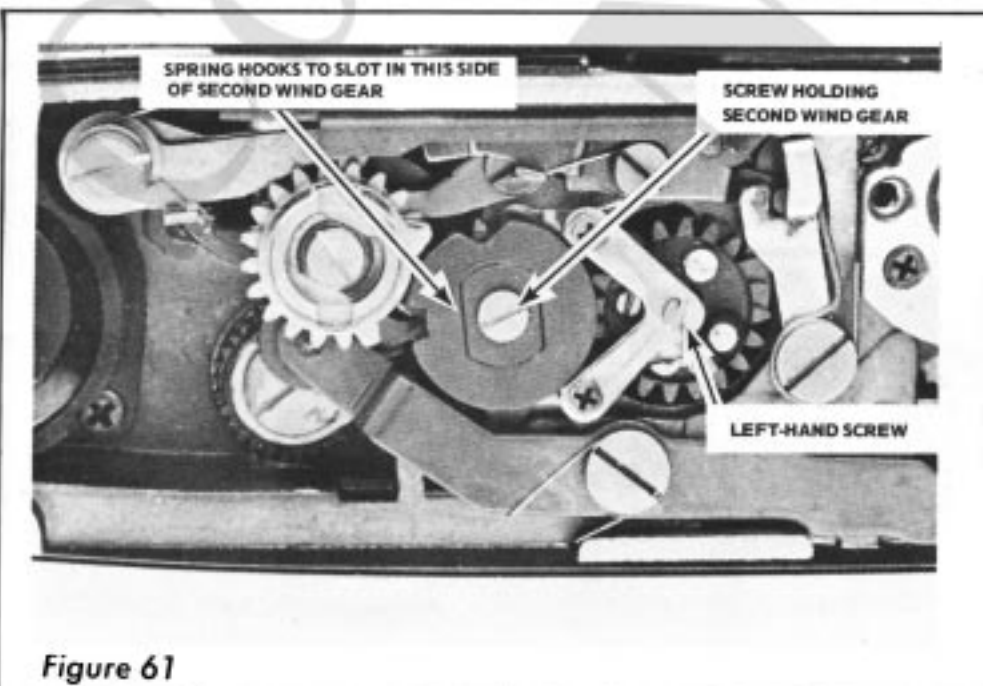

Figure 61

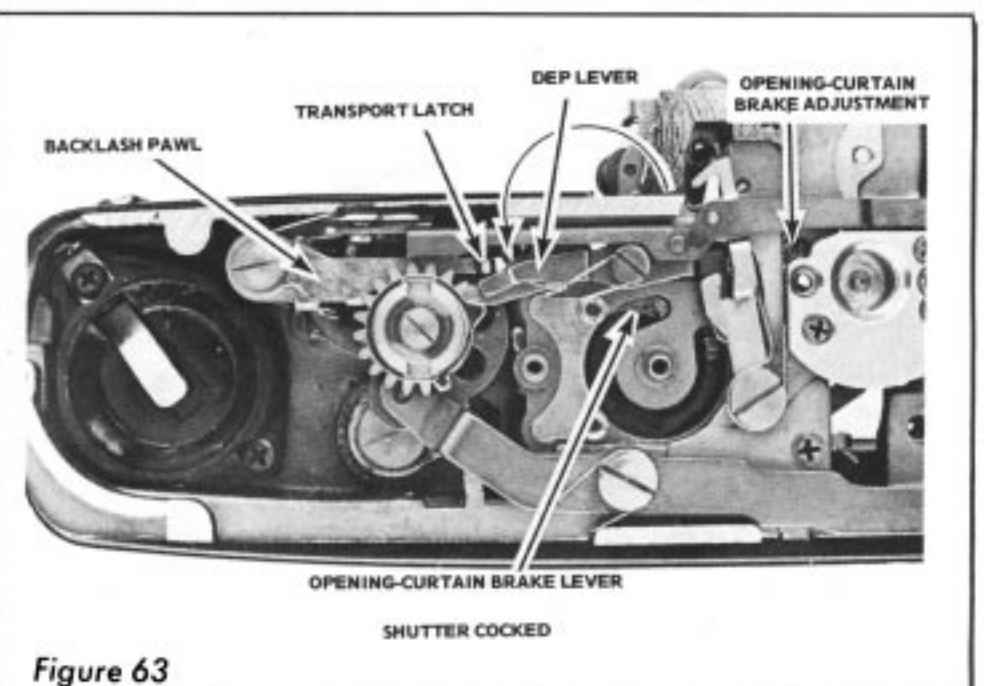
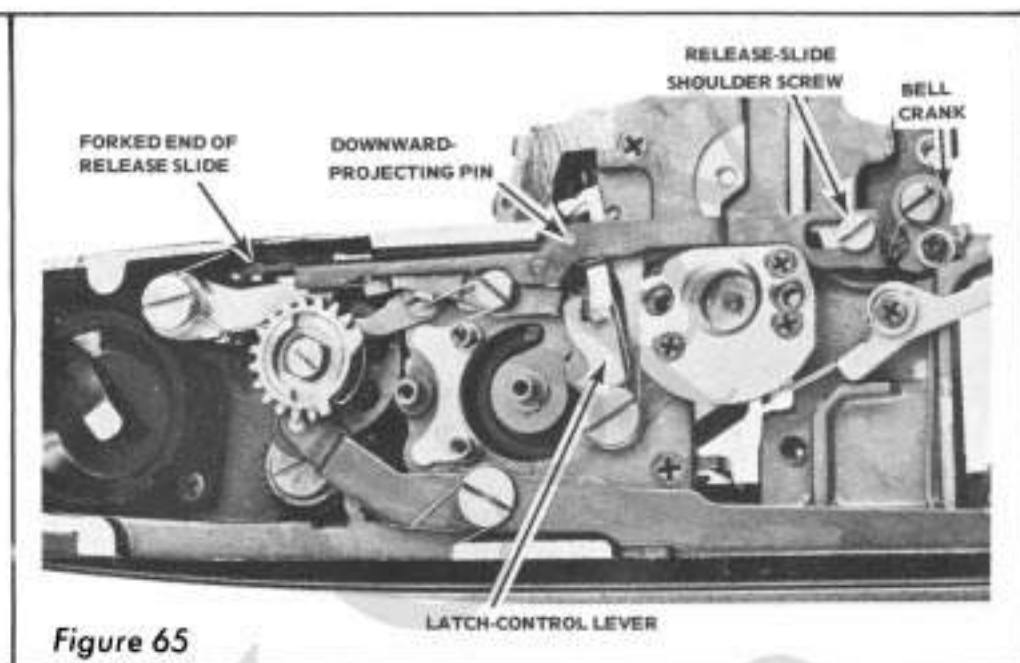
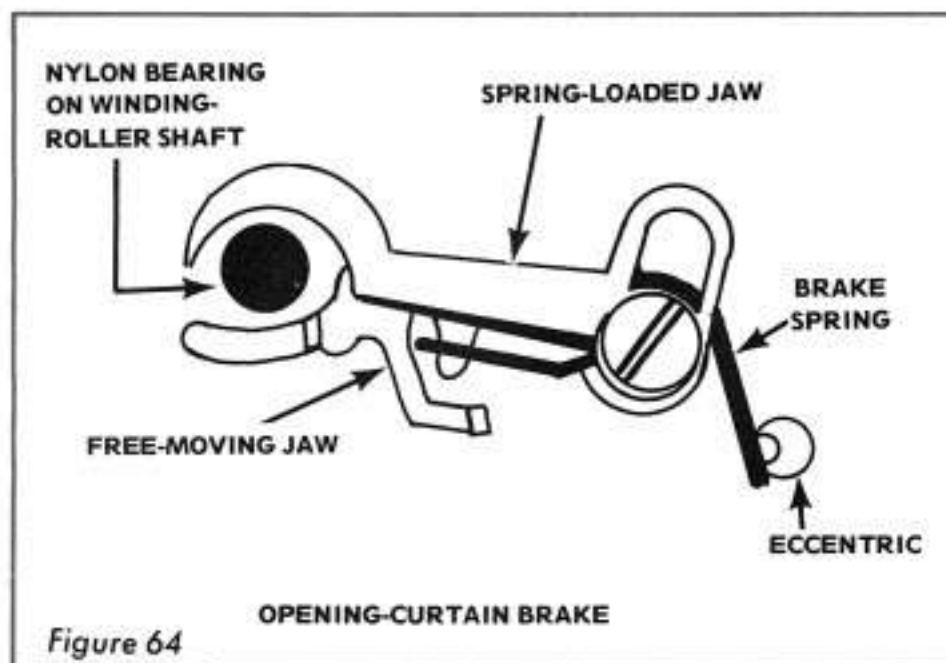

Figure 63



The top lever is a backlash pawl that prevents the first wind gear from turning in the reverse (clockwise) direction. But it's the lower lever — the transport latch — that latches the transport cam, preventing further rotation in a counterclockwise direction. Latching the transport cam simultaneously arrests the first wind gear (they're both parts of the same unit). So, once the shutter's cocked, you can't advance the wind lever a second time.

When the opening curtain releases, the opening-curtain wind gear spins clockwise. The stud on the opening-curtain wind gear then frees the DEP lever. And the spring-loaded DEP lever, pivoting clockwise, pushes the transport latch away from the transport cam. Now, the first wind gear is free to turn as you advance the film for the next exposure.

A second function of the opening-curtain-wind-gear stud is to actuate the opening-curtain brake lever, Fig. 63. As the opening-curtain wind gear nears the end of its clockwise rotation, the stud drives the opening-curtain brake lever toward the front of the camera.

The braking action in the OM-1 is quite unique — and effective. Each curtain has its own brake. And each brake simultaneously dampens two curtain parts: the curtain-wind gear and the curtain-winding roller.

Each winding-roller brake is a clamp, two jaws that close to grasp a nylon bearing on the winding roller, Fig. 64. One brake jaw is spring-loaded; the other jaw moves freely (the portion of the opening-curtain brake pointed out in Fig. 63 is the free-moving jaw). In operation, both brakes are identical.

To see how the brakes work, consider that the opening curtain is

now traveling across the focal-plane aperture to expose the film. So the opening-curtain wind gear is spinning clockwise. Near the end of this clockwise rotation, the stud on the opening-curtain wind gear strikes the free-moving brake jaw — that drives the jaw against the nylon bearing attached to the opening-curtain winding roller.

Once the free-moving jaw engages the nylon bearing, it pulls the spring-loaded jaw against the other side of the bearing. Combined, the two jaws act as a gentle vise, clamping the opening-curtain winding roller to prevent curtain bounce.

A second braking action results from the spring pressure on the spring-loaded jaw. The opening-curtain wind gear has to turn against the brake-spring pressure. Consequently, the spring-loaded jaw adds a damping action to the opening-curtain wind gear.

There's an adjustment for the opening-curtain brake at the bottom of the camera. The screwdriver-slotted brass stud shown in Fig. 63 is one end of an eccentric pin — the other end of the pin serves to hook the

opening-curtain-brake spring. By turning the eccentric pin from the bottom of the camera, you can increase or decrease the spring pressure.

The right amount of brake-spring pressure stops the opening-curtain wind gear slightly before its stud reaches the end of the base-plate slot. Try turning the opening-curtain wind gear to the cocked position (just push the wind-gear stud counterclockwise, from the position shown in Fig. 62 to that shown in Fig. 63). Then, hold the closing-curtain wind roller and release the opening curtain. You should now be able to see a slight space gap (less than half a millimeter) between the wind-gear stud and the end of the base-plate slot, Fig. 62.

Insufficient braking action (no space gap) could result in bounce — the wind-gear stud strikes the end of the base-plate slot and bounces back. Too much braking action (a larger space gap) could stop the opening curtain before its bar clears the focal-plane aperture.

The third function of the wind-gear stud is to disengage both pallets of the

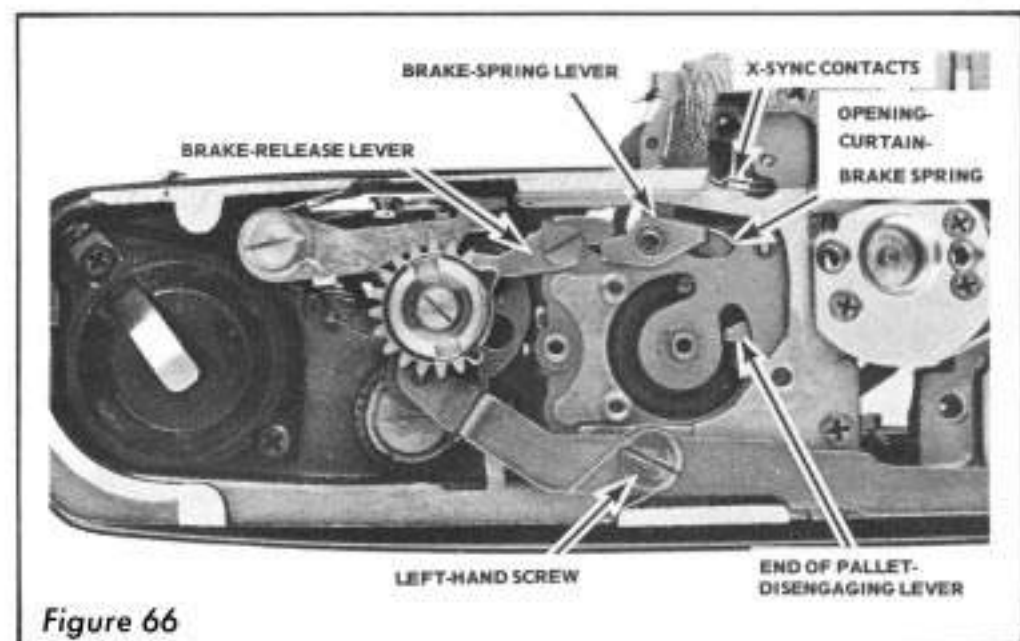

speeds escapement. In the shutter-cocked position, the wind-gear stud comes against one end of the pallet-disengaging lever (visible in Fig. 66 after removing the DEP lever). The pallet-disengaging lever then swings against the pallet-control levers.

Before removing the release slide, note the position of the bell-crank spring — one end hooks against the bell-crank eccentric and the other end hooks to the downward-projecting tab of the release slide, Fig. 65. Also, notice the downward-projecting pin on the release slide — to the left of the latch-control lever. The pin pushes the latch-control lever from left to right when you depress the release button.

Now, take out the release-slide shoulder screw, Fig. 65. Swing the release slide up and away from the camera. Then, lift the forked end of the release slide off the shouldered post of the release-rod lever. On reassembly, be sure to seat the release slide with its downward-projecting pin to the left of the latch-control lever.

The latch-control lever fits over a pin on the DEP lever. In the shutter-released position, the DEP lever prevents the left-to-right movement of the release slide — that's why you can't depress the release button until the shutter is cocked. As the opening-curtain wind gear rotates to the cocked position, it pushes the DEP lever out of the slot in the latch-control lever. Now, the latch-control lever is free to move as you depress the release button.

To remove the latch-control lever, first disconnect its spring from the side of the tripod socket. Then, remove the shoulder screw (two shoulders, one for the lever and one for the spring) and lift out the latch-control lever.

Next, disconnect the end of the DEP-lever spring from the bridge-support post. Take out the retaining screw and remove the DEP lever.

A shouldered bushing under the DEP lever passes through the hole in the brake-spring lever, Fig. 66. Right now, the brake-spring lever just sits on the bottom of the curtain-control module. But in action, the brake-spring lever relieves the pressure of the opening-curtain-brake spring at the beginning of the shutter-cocking cycle; that's how the wind stroke gets its satin-smooth start.

A downward-projecting tab on the brake-spring lever hooks against the inside of the opening-curtain brake

spring. At the start of the wind cycle, the cam under the first curtain wind gear pushes the brake-release lever in a clockwise direction. And the brake-release lever presses the brake-spring lever against the opening-curtain-brake spring.

Remove both the brake-spring lever and the brake-release lever. To remove the mirror-cocking lever, disconnect the spring and take out the left-hand screw shown in Fig. 66.

Fig. 66 also points out the X-sync contacts. The part that closes the X-sync contacts is the free-moving jaw of the opening-curtain brake. Later in the disassembly, you'll be able to see the contact operation more clearly. But notice that it's possible to reach the X-sync contacts from the bottom of the camera — even though the contacts mount to the curtain-control module inside the camera. So you can reach the X-sync contacts for a forming adjustment without removing the mirror cage.

Now, hold the transport latch away from the first wind gear; that disengages the transport cam, permitting you to advance the wind lever. Advance the wind lever until the first wind gear reaches the position shown in Fig. 67. Here, the

first wind gear clears the backlash pawl and the transport latch. Note the positions of the springs for the two levers — one at the top (for the backlash pawl) and one underneath (for the transport latch). Remove both the backlash pawl and the transport latch by disconnecting the springs and taking out the screw.

There's yet another left-hand screw holding the first wind gear. As you remove the first wind gear, watch for the ball bearings — the one-millimeter balls are now loose. The ball bearings may remain around the pivot post for the first-wind-gear assembly; or, because of the lubrication, they may stay within the track beneath the mirror-cocking cam.

On reassembly, replace the first-wind-gear assembly, the transport latch, and the backlash pawl. Then, advance the wind lever until the transport latch engages the transport cam. Now, the first wind gear is in the proper position for timing the second wind gear.

Such a thorough disassembly is desirable for cleaning and essential if you're going to remove the curtain-control module. Notice the two screws holding the support plate in Fig. 68.

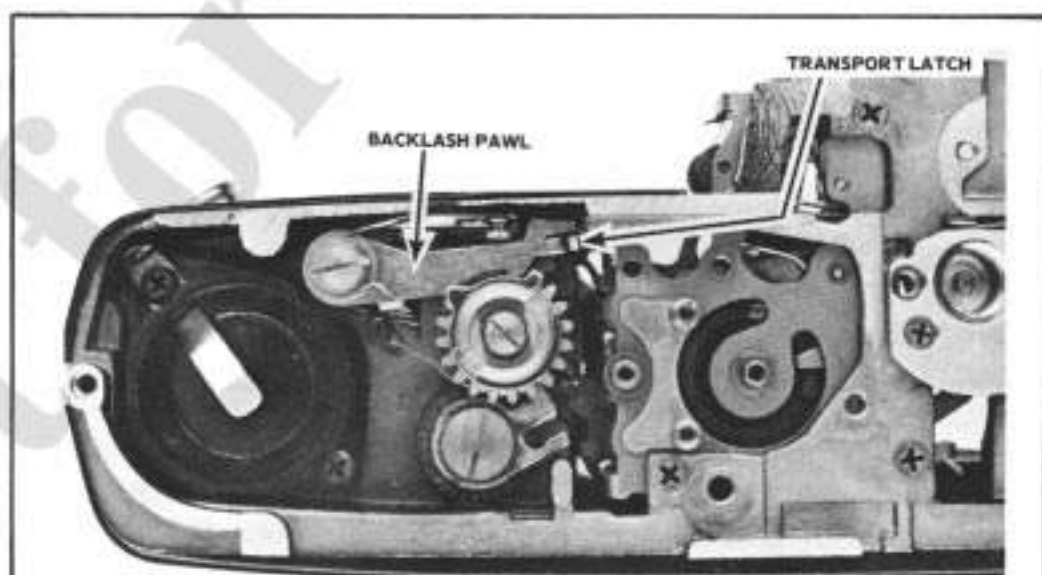

Figure 67

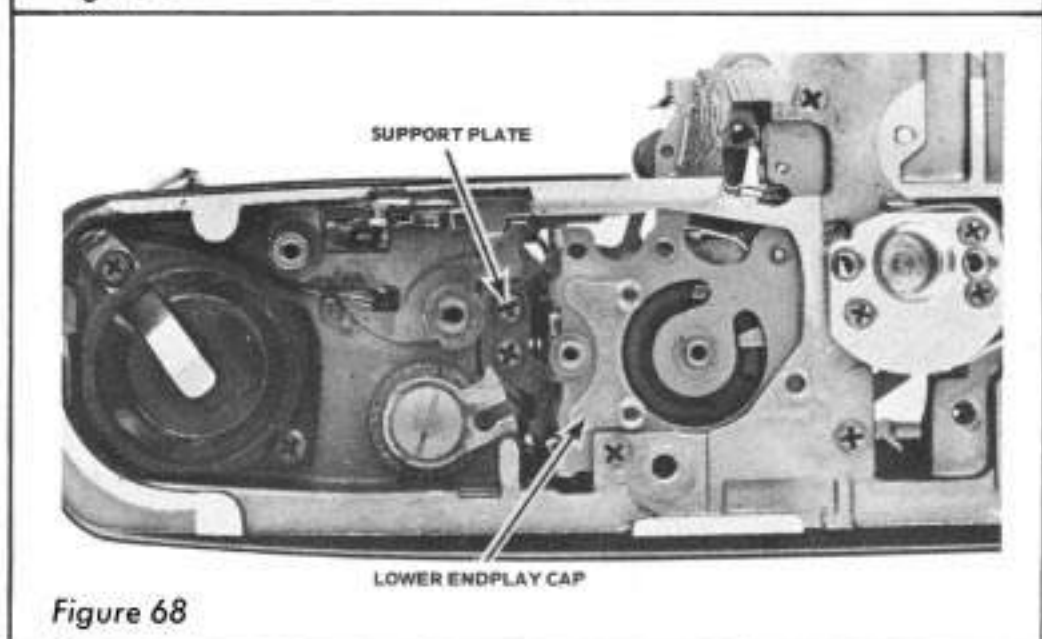

Figure 68

The support plate carries one of the guide rollers for the curtain cords. And you must remove the support plate to take out the curtain-control module.

You can, however, conveniently flush-clean the mechanism by just removing the endplay caps for the winding rollers. Take out the lower endplay cap, Fig. 68, by unscrewing the two bridge-support posts; that exposes the lower pivots of the curtain-winding rollers, Fig. 69. Removing the upper endplay cap exposes the upper pivots for cleaning and lubrication.

### Timing The Shutter Curtains

There's one hazard in removing the endplay caps — it's now possible to lose the timing between the curtain-winding rollers and the curtain-wind gears. But, by the same token, removing the endplay caps provides a convenient shortcut for timing the curtains.

With the lower endplay cap removed, you can disengage the closing-curtain winding roller from the closing-curtain wind gear. Just push down the closing-curtain winding roller until its pinion disengages. Then, turn the closing-curtain winding roller to adjust the closing-curtain position.

Removing the upper endplay cap allows you to disengage the opening-curtain winding roller from the opening-curtain wind gear. You can then lift the opening-curtain winding roller high enough to disengage its pinion.

We found this shortcut timing technique to be helpful in replacing the curtains. It's possible to remove and replace the curtains without disturbing the timing. But if you remove the curtain-winding-roller

pinion shafts, you'll have to retime the curtains. Replacing the curtains can be frustrating, even if you don't worry about curtain timing. The main problem is keeping the curtain cords seated around their guide rollers. Until you apply tension to the take-up rollers, the cords have a mischievous way of slipping off.

But once the curtains are in place — and the cords are properly routed around the guide rollers — you can adjust the curtain timing. Just disengage the closing-curtain winding roller and turn the roller until the lead edge of the closing curtain aligns with its scribe mark. Then, turn the closing-curtain wind gear until its lug engages the closing-curtain latch. Re-engage the winding-roller pinion with the closing-curtain wind gear and replace the lower endplay cap.

Now, turn the opening-curtain wind gear to the cocked position — until the opening-curtain latch drops into place. Disengage the opening-curtain winding roller from the opening-curtain wind gear. And turn the opening-curtain winding roller, winding on the opening curtain, until you have the one-bar overlap between the two curtains. Re-engage the opening-curtain winding roller with the opening-curtain wind gear and replace the upper endplay cap.

### Removing The Curtains

New curtains for the OM-1 come already attached to the take-up and winding rollers, Fig. 70. That's fortunate — recementing the cords to the rollers could be a delicate situation.

Each winding roller is in two sections — the actual roller shown in Fig. 70 and a pinion shaft. Screws hold the rollers to the pinion shafts, Fig. 71.

There's one screw holding each pinion shaft.

So why all the extra holes in the winding rollers? For one thing, the extra holes serve to lighten the weight. But there's a more important purpose — the extra holes permit fine adjustments for the curtain positions.

Changing the position of the pinion-shaft screw rotates the roller slightly with respect to the pinion shaft. For example, say that the closing-curtain bar doesn't quite center between the scribe lines — even though you've timed the gears to align the curtain as closely as possible. You can then make a fine adjustment by moving the pinion-shaft screw to another hole. If the curtain bar is slightly to the right of the scribe lines, move up the pinion-shaft screw (closer to the top of the camera).

Because of the two-piece winding-roller design, it's possible to remove the curtains without disturbing the gear timing. Leaving the pinion shafts in the camera — while removing the rollers — retains the timing between the pinions and the curtain-wind gears.

First, turn the curtain-wind gears to the fully released position. The curtain brakes then clamp the pinion shafts, holding the shafts in position. Both endplay caps should be in place to retain the timing.

Next, let off the take-up-rollers tensions by disengaging the lock springs from the tension-setting star nuts. Use a screwdriver to hold each take-up roller central shaft from the top of the camera as you unscrew the star nuts in a clockwise direction.

Take off the E-rings holding the upper ends of the take-up rollers and remove the take-up rollers bridge. Then, remove the winding-rollers bridge, Fig. 71. Notice that a bearing

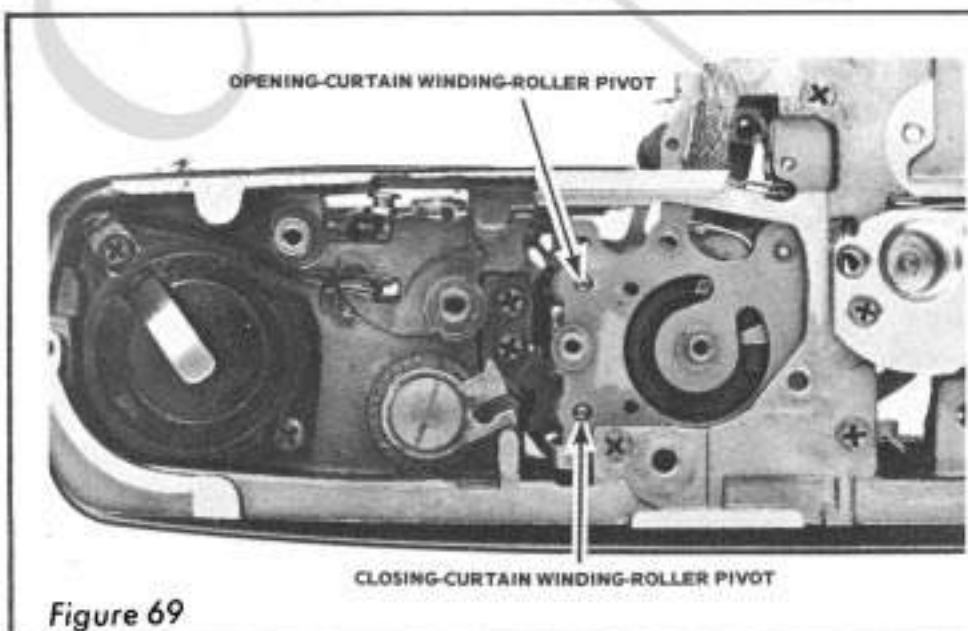

Figure 69

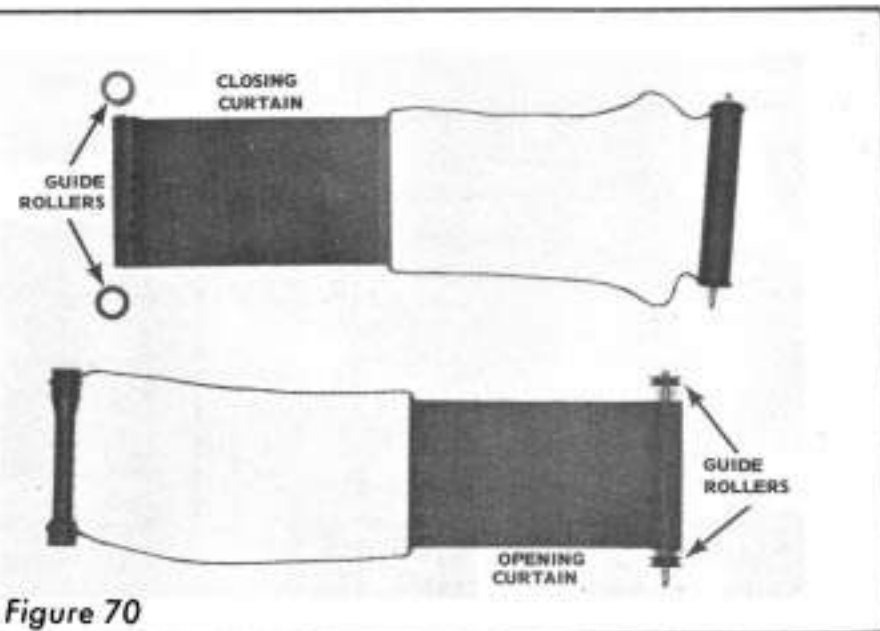

Figure 70

underneath the winding-rollers bridge passes through a guide roller for the opening-curtain cord. The guide roller sitting on top of the closing-curtain winding roller, Fig. 72, routes the cord to the opening-curtain winding roller. Two tabs on the winding-rollers bridge pass to the outside of the cord.

You can now remove the screws holding the winding rollers to their pinion shafts. Lift out both winding rollers to remove the curtains.

The drawing, Fig. 73, shows how the curtains sit in the camera body. The opening curtain runs behind the closing curtain (as seen from the front of the camera). And the cloth side of each curtain faces the back of the camera.

Both pinion shafts remain in the camera body, still timed properly to the curtain-wind gears, Fig. 74. Notice the support plate over the closing-curtain pinion shaft — this is the support plate we pointed out earlier, held by two screws from the bottom of the camera (Fig. 68). The lower guide roller for the opening-curtain cord seats over the bearing on the support plate; the cord then passes to the outside of the guide roller and to the inside of the two support-plate tabs.

### Replacing The Curtains In The OM-1

There's no doubt many techniques you can use to replace the curtains in the original timing positions. Here's one that works with reasonable convenience.

First, install the opening-curtain winding roller over its pinion shaft. Make sure that the lower cord passes around the outside of the two pinion shafts, as in Fig. 73. Start the lower guide roller in position. But before seating the guide roller, position the curtain cord within the guide-roller track. Then, seat the guide roller with the cord passing to the inside of the two guide tabs of the support plate.

Next, seat the closing-curtain winding roller over its pinion shaft and replace the screw. Place the upper guide roller on top of the closing-curtain winding roller, routing the opening-curtain cord around the guide-roller track, Fig. 72. With the cord in position, replace the winding-rollers bridge — remember, the bearing on the winding-rollers bridge must pass through the hole in the guide roller.

Pull the opening curtain from left to right — check to make sure that the opening-curtain cords remain seated within their guide rollers. Right now,

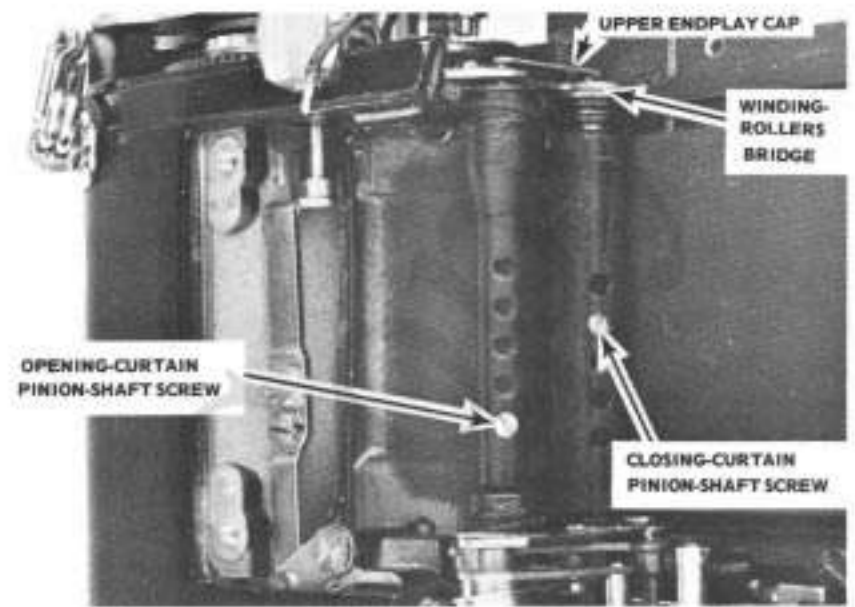

Figure 71

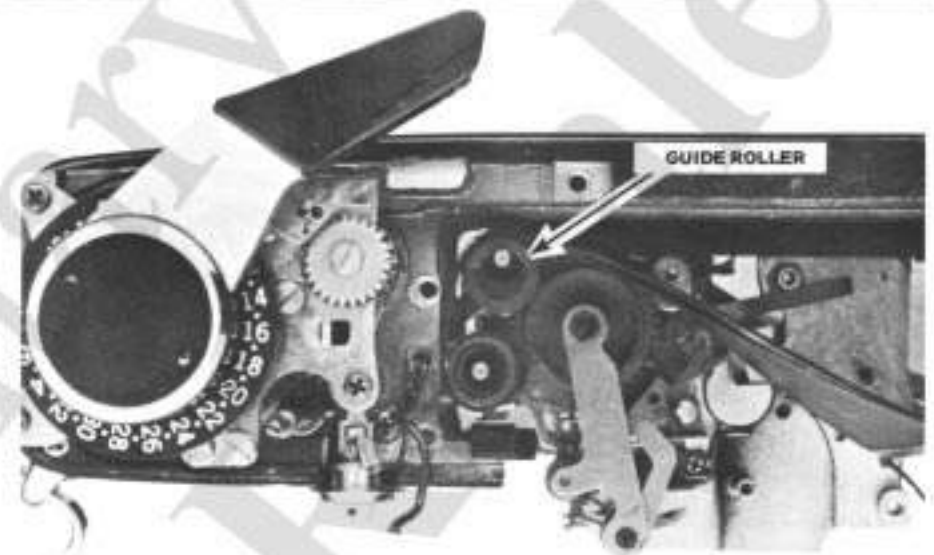

Figure 72

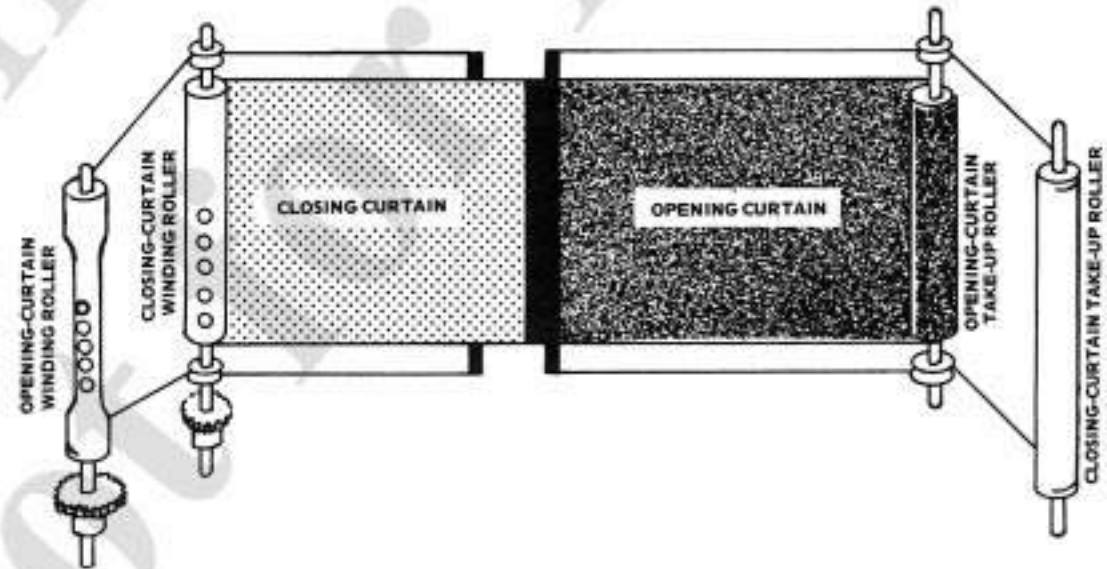

Figure 73

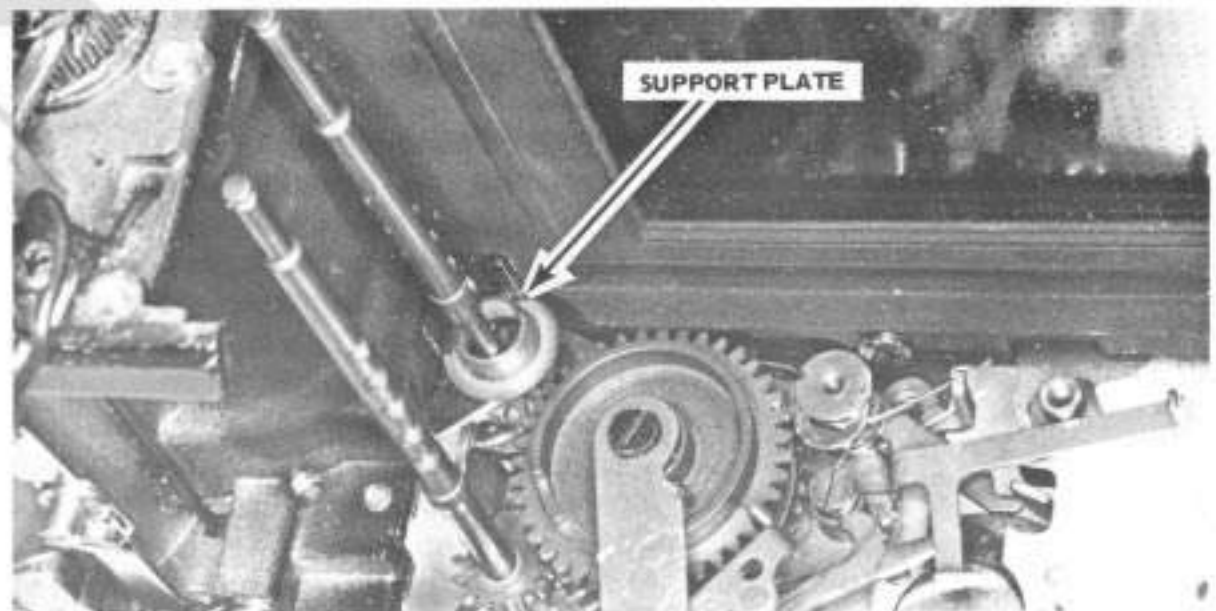

Figure 74

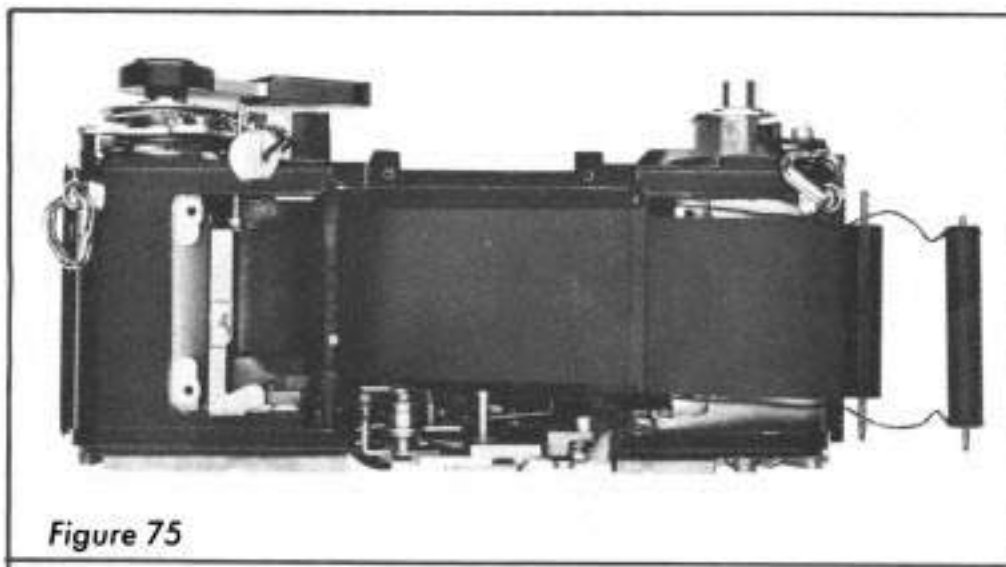

Figure 75

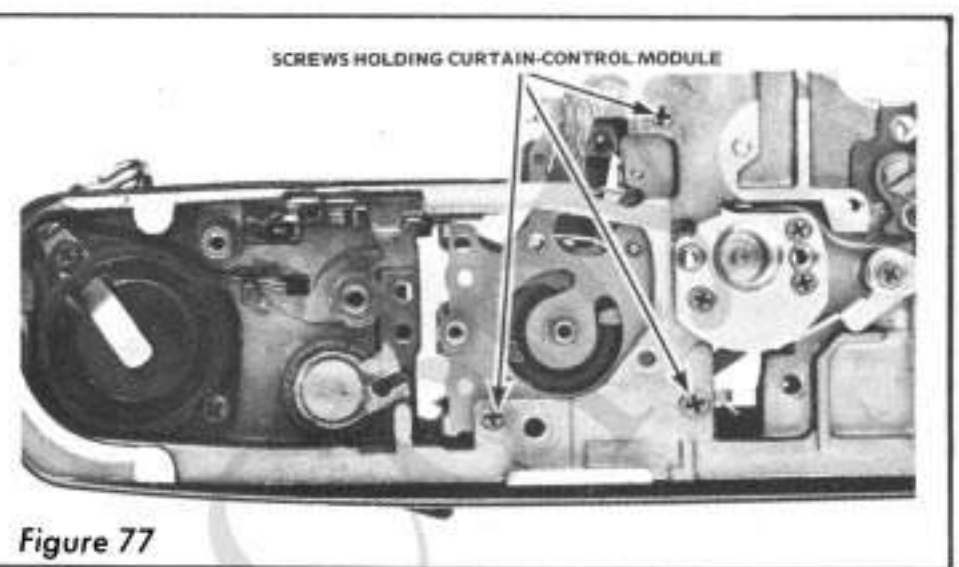

Figure 77

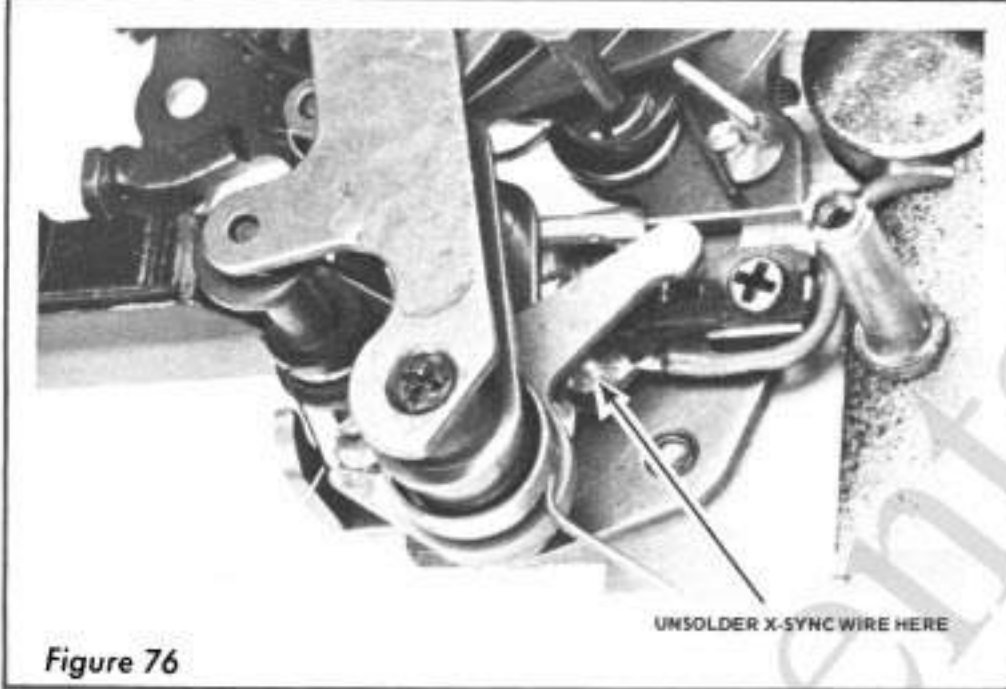

Figure 76

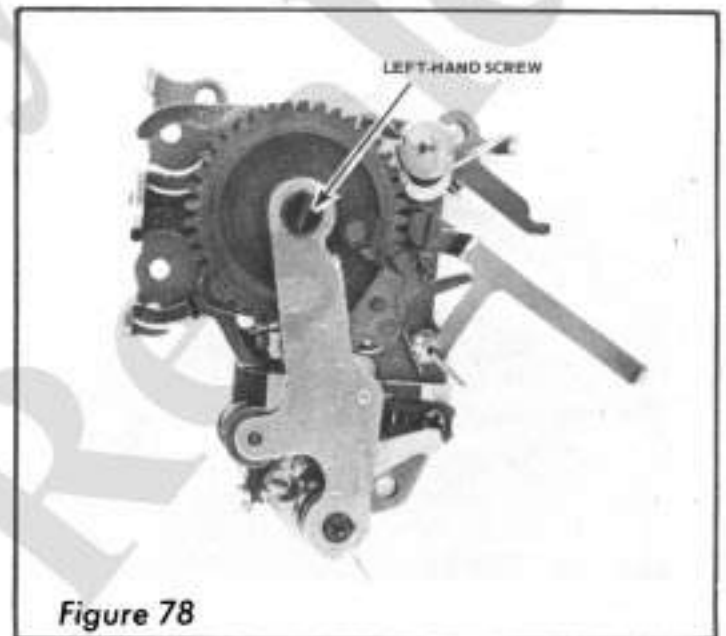

Figure 78

the holes in the opening-curtain winding roller may nearly align with the holes in the pinion shaft. But to retain the original timing, you want the holes at the other side of the winding roller facing the front of the camera. So turning the opening-curtain winding roller 180 degrees until the holes align. Then, replace the pinion-shaft screw.

Chances are the opening curtain is now to the front of the closing curtain; the opening curtain must be to the back of the camera. So pass the closing-curtain take-up roller through the opening-curtain cords. The opening curtain should now be behind the closing curtain, Fig. 75. And the two curtain bars should overlap at the closing side of the focal-plane aperture.

Now, turn the opening-curtain wind gear from the bottom of the camera to the cocked position — that winds on both curtains. Position the washer and the guide roller over the lower shaft of the opening-curtain take-up roller. Then, route the closing-curtain lower cord around the guide roller.

Seat the lower pivot of the opening-curtain take-up roller in its bearing hole. Next, seat the lower pivot of the

closing-curtain take-up roller.

Place the washer and the upper guide roller over the pivot at the top of the opening-curtain take-up roller. And loop the closing-curtain cord around the guide roller. After replacing the take-up-rollers bridge and the E-rings, turn the closing-curtain take-up roller to draw the cords taut — make sure that the cords remain seated around their guide rollers. Then, replace the star nuts and add the initial tensions.

Turning the star nuts counterclockwise adds tension. In our evaluation camera, the curtain-travel times measured 14.5 milliseconds edge-to-edge — 13 milliseconds with the travel-time masks.

As we indicated earlier, the cords do have a way of slipping off their guide rollers until you apply the initial tension (especially on the take-up-rollers side). The first time the cords slip off, try to restrain yourself — there's a temptation to do something you might regret. The second time the cords slip off, you might try a trick we found helpful. After seating the guide rollers on the opening-curtain take-up roller, we installed a clip at each end to hold the guide rollers in place. The



Figure 79

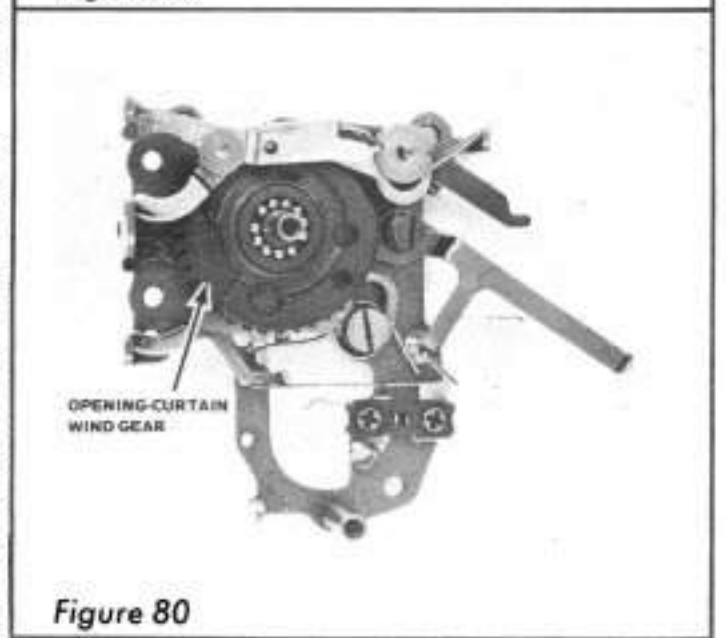

Figure 80

idea is to hold the guide roller against the ends of the take-up roller — if the guide rollers can't slide up or down, the cords should stay in place. We left the clips installed until we had applied the tensions to the take-up rollers.

### Removing The Curtain-Control Module

The curtain-control module comes out as a complete unit. First, lift out the opening-curtain pinion shaft. Then, remove the two screws at the bottom of the camera that hold the guide-roller support plate, Fig. 68. Lift out the support plate and the closing-curtain pinion shaft.

Now, disconnect the spring from the high-speed cam follower — that allows you to swing aside the high-speed cam follower far enough to unsolder the red wire from the X-sync contacts, Fig. 76.

After disconnecting the wire, remove the three module screws at the bottom of the camera, Fig. 77. And lift out the complete curtain-control module, Fig. 78.

There are a couple of precautions if you're going to disassemble the curtain-control module. For one, the slotted screw holding the wind-gear bridge, Fig. 78, has a left-hand thread. Another precaution is to watch out for loose ball bearings — each curtain-wind gear has two ball races, one on the top of the gear and one on the bottom. And the eleven tiny (one millimeter) balls in each of the four races are loose once you remove the gears.

### Disassembly Of The Mirror Cage

The mirror cage consists of two side panels that mount to the front plate. Three screws hold each side panel — one at the top of the panel, Fig. 81, and two at the front.

To get to the front mounting screws, you'll have to remove the lens-mounting ring, the two sensing rings, and the trim plate around the lens opening. Fig. 82 points out three of the four panel-mounting screws. But the fourth screw hides under the aperture-sensing-ring stop. So remove the aperture-sensing-ring stop and take out the four side-panel screws.

Then, take out the screws at the tops of the side panels. And separate the two side panels from the front plate. The mirror bracket remains with the side panel shown in Fig. 83, held by a screw to the mirror-lifting lever.

Fig. 84 shows the mirror-angle adjustment after reassembly. Turning the adjustment screw changes the angle of the mirror in the viewing position. You can reach the

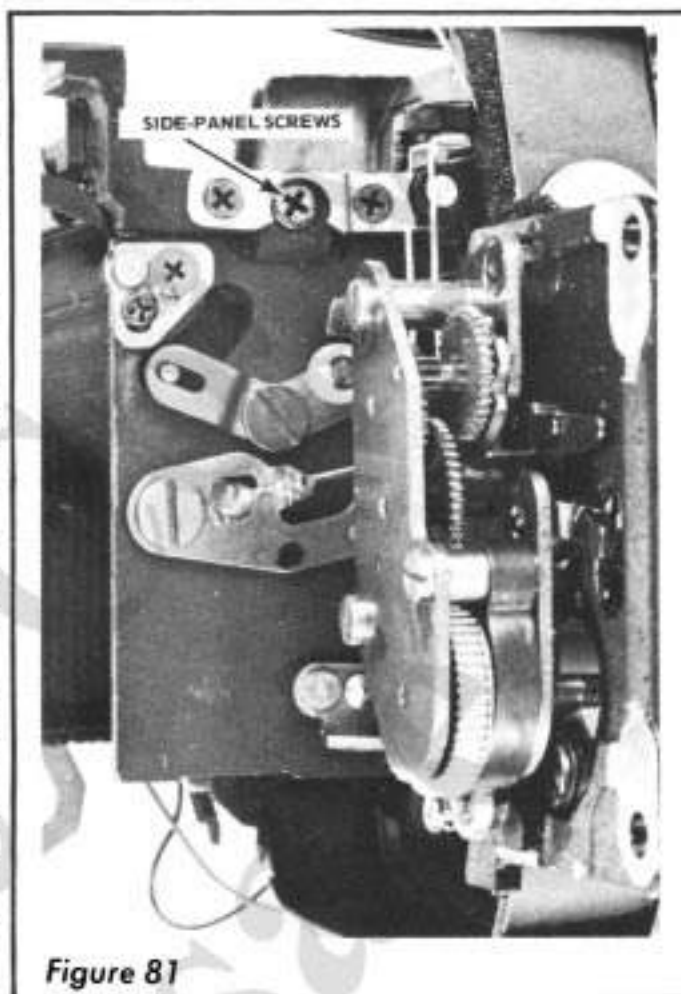

Figure 81

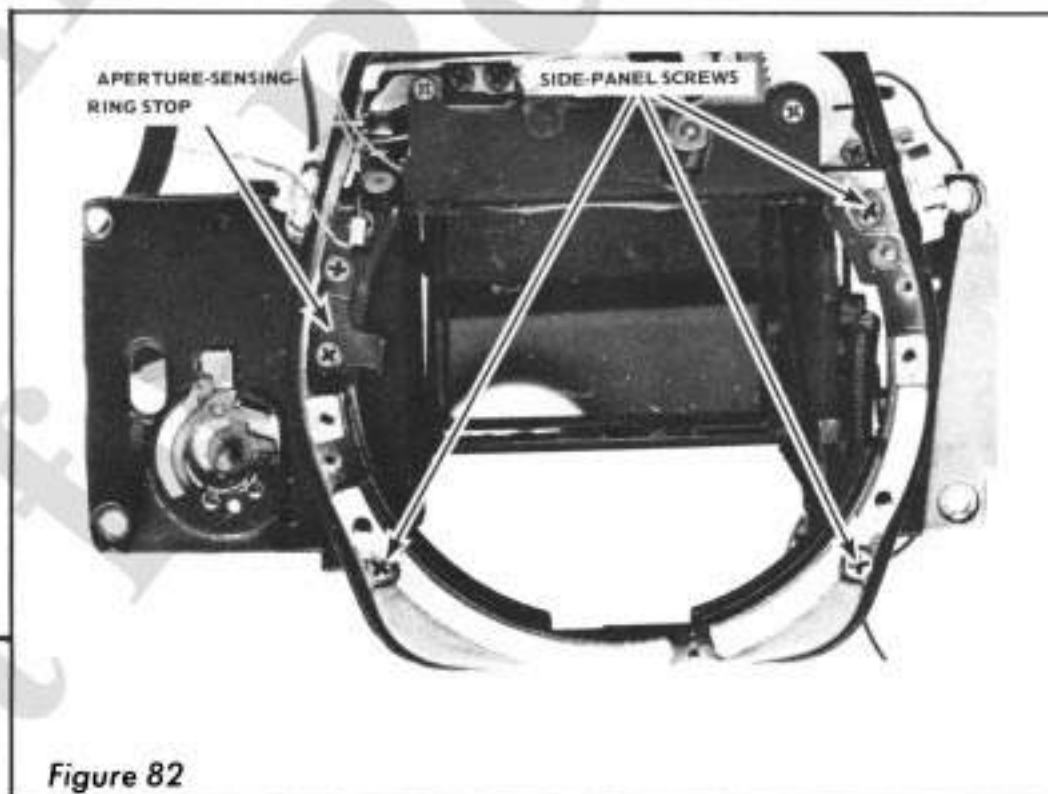

Figure 82

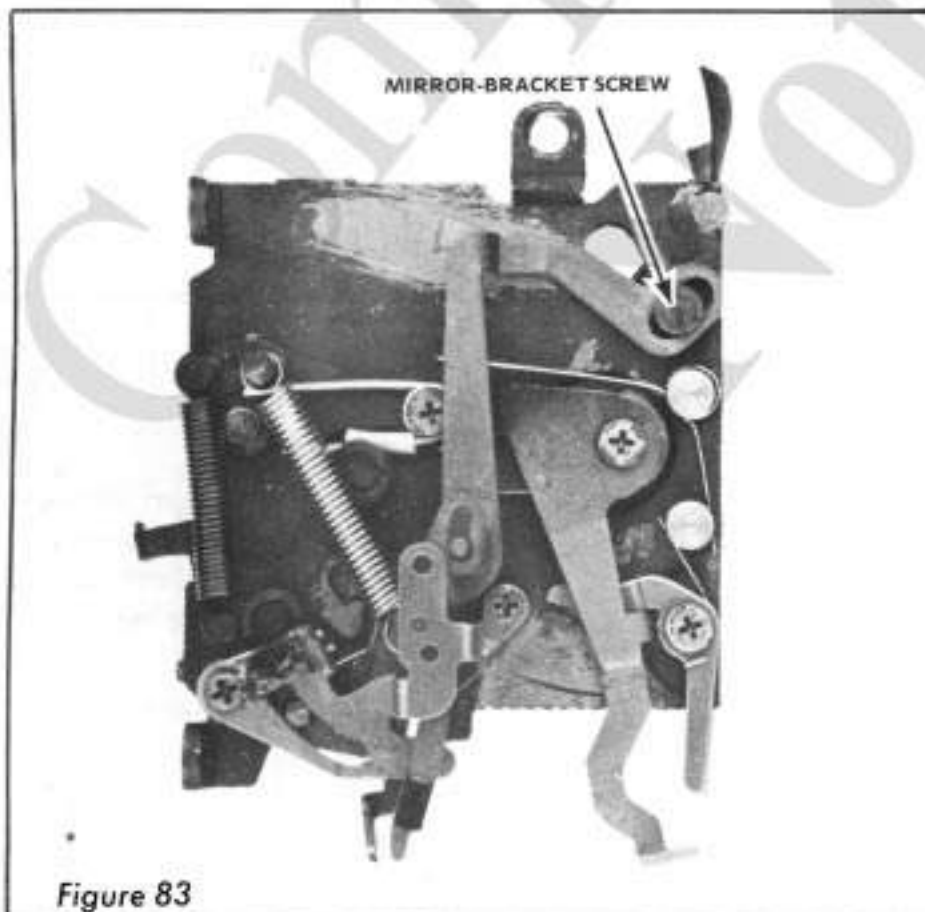

Figure 83

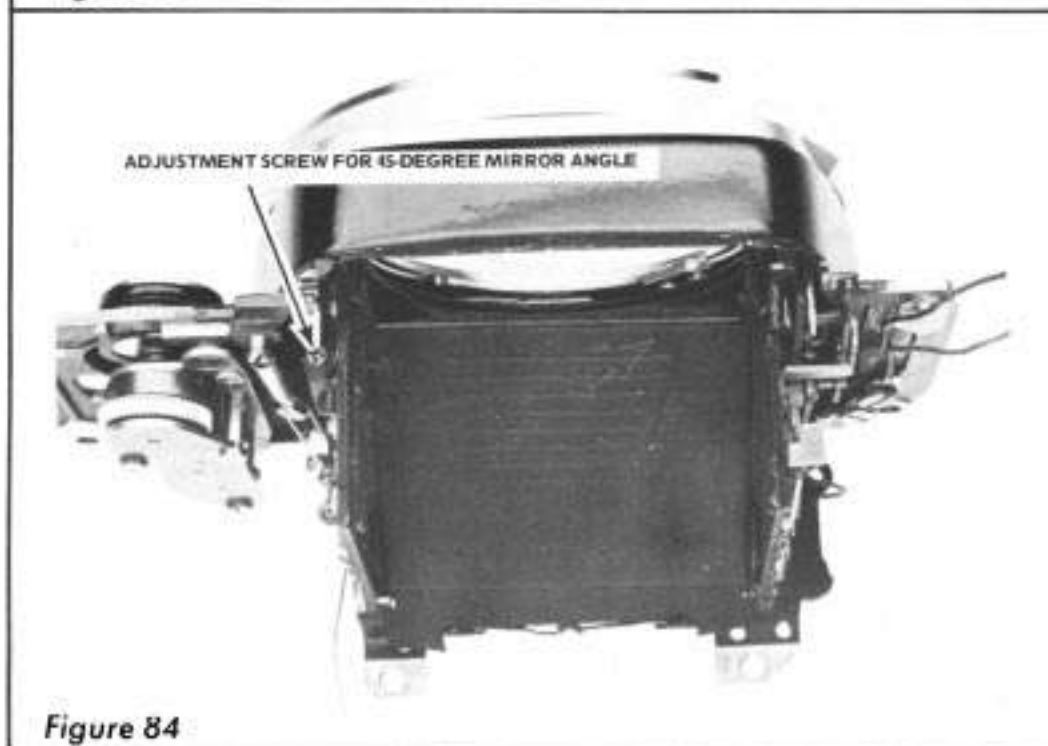
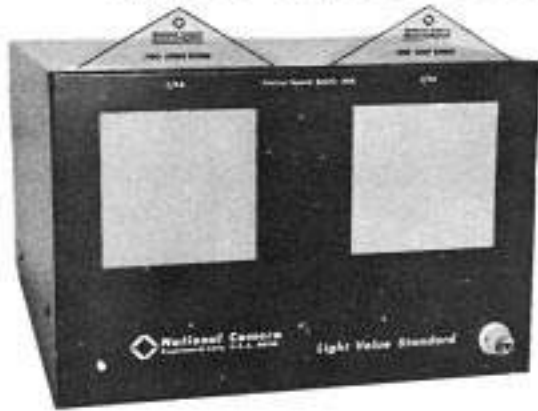

Figure 84

# LIGHTING THE WAY

## LIGHT VALUE STANDARD



LIGHT VALUE STANDARD will let you meet today's sensitive standards for measuring light response. You can check any meter instantly — at your bench or at your counter.

Use with meters or automatic cameras. Stable uniform light output without color temperature change over a wide voltage range. Eight light levels, precision calibrated from  $f/2$  to  $f/22$ . The sequentially aged lamps are related to the uniform light output directly traceable to National Bureau of Standards — precision within 5%. Lightweight — only 12 lbs. 10 oz. Compact as a portable typewriter. No meters to deteriorate or fail.

S-7100 FOB Englewood **\$195.00**

## COMPARALUMEN



The new COMPARALUMEN is National Camera's advanced version of the Light Value Standard. Even easier to use, with built-in power regulator — no calibration needed to compensate for variations in voltage. Powered by filtered direct current for uniform, flickerless light output.

The new Comparasystem permits observation of very subtle changes in the camera system under measurement so that even a tiny fluctuation in power to the light standard lamps is visible. The Comparalumen minimizes these fluctuations so that the technician can more easily see the small variations in diaphragm movement, shutter operation, and similar subtleties. The Comparalumen also provides all the outstanding features and performance of the National Camera Light Value Standard.

C-6820<sup>®</sup> FOB Englewood **\$295.00**

**National Camera**  
2000 West Union Ave.  
Englewood, Colorado, 80110

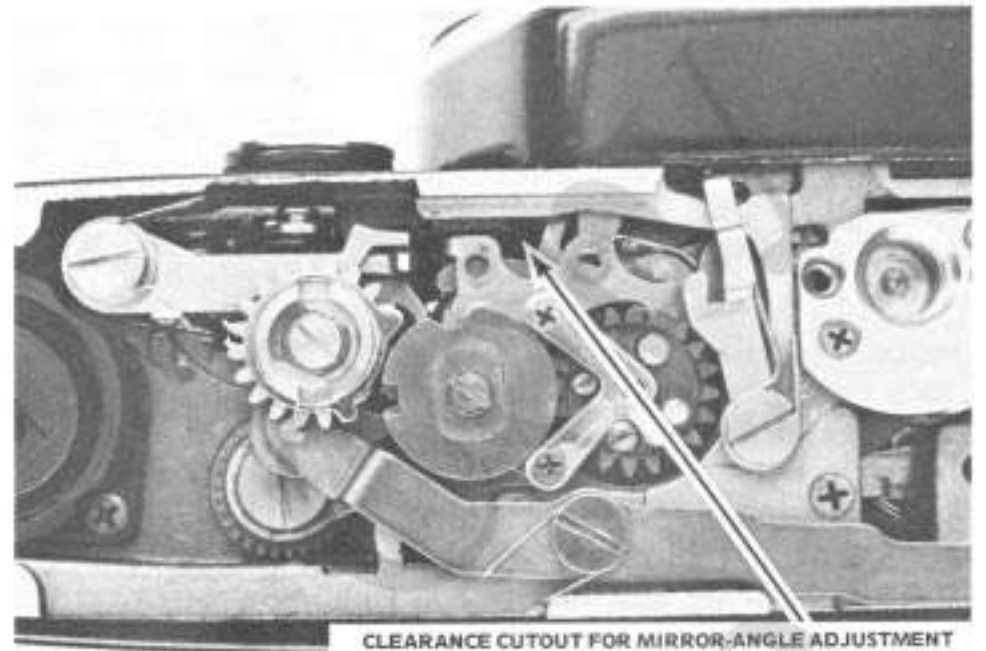

CLEARANCE CUTOUT FOR MIRROR-ANGLE ADJUSTMENT

Figure 85

mirror-angle adjustment from the bottom of the camera after partial disassembly, Fig. 85.

### Sync Circuits In The OM-1

The sync-selector switch remains with the front plate. Turning the sync-selector switch to the "FP" setting simply closes a contact to a ground connection.

The sync-circuit schematic, Fig. 86, shows the sync-selector switch in the X-sync position. Here, the FP-sync contacts just act as a safety switch for the X-sync contacts. Notice that closing the FP-sync contacts does not fire the flash — the X-sync contacts must be closed to connect the circuit to ground.

But moving the sync-selector switch to the "FP" setting connects the FP-sync contacts directly to ground. Now, closing the FP-sync contacts fires the flash as the mirror rises to the taking position — before the X-sync contacts close. In our evaluation camera, the FP-sync delay measured 14

milliseconds.

### Conclusions On The OM-1

The tiny OM-1 appears to be everything its supporters claim — compact and comfortable, sturdy and precise. And even though the shutter is purely mechanical, it shows genuine innovation — all those conventional parts that were redesigned to compress the camera's dimensions.

Before starting this report, we had thought of the OM-1 as a natural second camera — a camera that one could carry conveniently, always ready for that unexpected picture. But the OM-1 deserves more than that; it's also a worthy first, or only, camera. With its array of accessories, its full-frame 35mm format, and its sturdy design, the OM-1 offers a formidable challenge to bulkier 35mm systems. That's quite an impressive accomplishment for such a tiny camera.

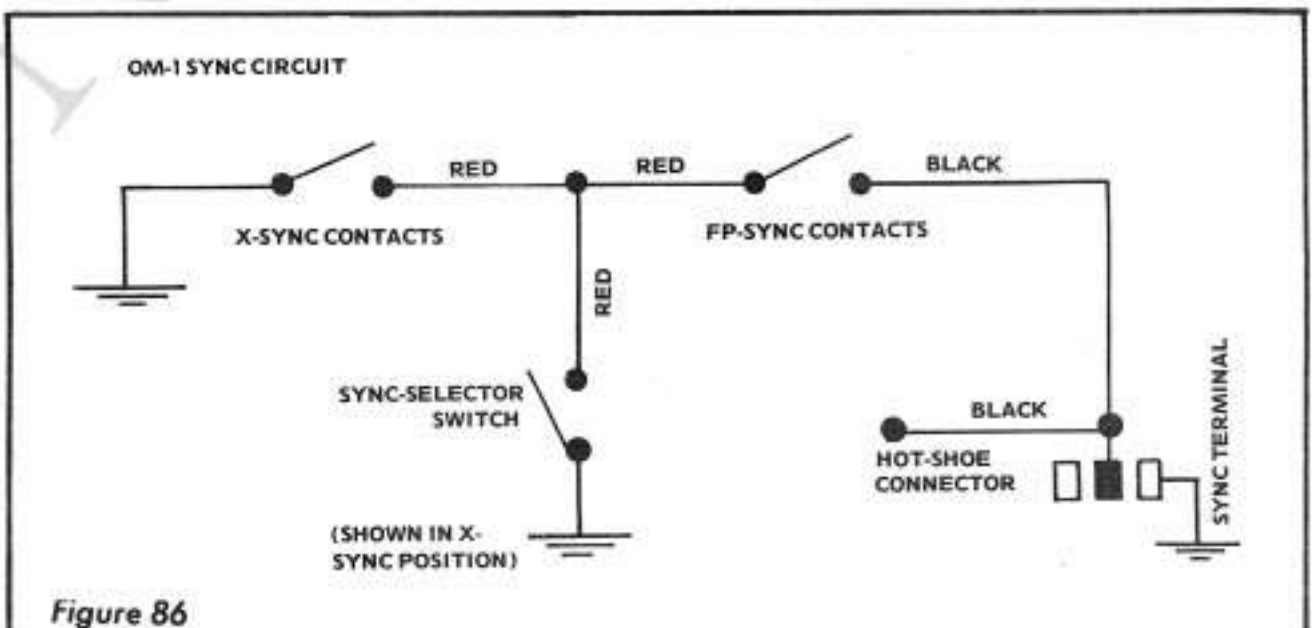

Figure 86